

DISCIPLINAS

BÁSQUETBOL, VOLEIBOL, FÚTBOL AMERICANO, WATERPOLO, BALÓN MANO,
PING PONG, BADMINTON, NATACIÓN, CICLISMO, ATLETISMO Y ÚTILES



 **RUNIC**®



#3

RK3R300

HOT #3
CAUCHO
VULCANIZADO
8 PANELES



#5

RK5R500

CAUCHO
VULCANIZADO
8 PANELES



#5

RK5KUH36

PU CUERO HIGROSCÓPICO
VULCANIZADO
8 PANELES



#6

RK6100

FAST BREAK
PU VULCANIZADO
8 PANELES



#5

RK5U100

1000
PU VULCANIZADO
8 PANELES



#6

RK6U101

1000
PU VULCANIZADO
8 PANELES



#7

RK7R250

DUNKO
CAUCHO
VULCANIZADO
12 PANELES



#7

RK7U100

1000
PU VULCANIZADO
8 PANELES



#7

RK7R400

CAUCHO
VULCANIZADO
8 PANELES



#7

RK7U900

PU
VULCANIZADO
12 PANELES



#7

RK7UY70

100% TPU



#7

RK7U200

PULSE
PU VULCANIZADO
12 PANELES



#7

RK7UY90

100% TPU



#7

RK7UY06

100% PU



TABLERO

MEDIDA TABLERO: 112 X 73.5 CM
REF: SBA006



TABLERO

MEDIDA TABLERO: 110 x 75 CM
REF: SBA007



TABLERO

DIÁMETRO ARO: 45 CM EN ACERO DE 16 MM
MEDIDA TABLERO: 120 X 80 CM
MATERIAL: PC Y MARCO DE ACERO
INCLUYE NET DE NYLON.
RESISTENTE A LA INTEMPERIE
REF: SBA008



INCLUYE UNA MINI
BOLA DE 5" Y UN
INFLADOR

MINI HOOP

DIÁMETRO ARO: 9"
MEDIDA TABLERO: 18" X 12"
ARO DE BALONCESTO MINIATURA PARA
INTERIORES, DE FÁCIL MONTAJE.
CON SOPORTE ACOLCHADO DE ESPUMA PARA
NO DAÑAR LAS PUERTAS DE LA CASA
REF: RS9PMH1



TABLERO CON POSTE

ALTURA: 1.65 A 2.1 M

DIÁMETRO ARO: 38 CM EN ACERO DE 16 MM

MEDIDA TABLERO: 33" X 23"

BASE: SE PUEDE LLENAR CON 35 GALONES DE AGUA O ARENA PARA MAYOR ESTABILIDAD. CON RUEDAS PARA FÁCIL TRANSPORTE Y NET TRICOLOR.

REF: RS9MBS82

TABLERO CON POSTE

MEDIDA TABLERO: 120CM X 80 CM

DIÁMETRO ARO: 45 CM. PARA BALONCESTO ESTÁNDAR

MEDIDA TABLERO: 120 X 80 CM.

BASE: 110 X 75 X 20 CM. MATERIAL POLIETILENO (PE)

ALTURA AJUSTABLE: DE 230 A 305 CM

POSTE: TUBO DE METAL DE TRES PIEZAS PARA MAYOR SEGURIDAD, ASEGÚRESE DE QUE LA BASE ESTÉ SIEMPRE LLENA DE AGUA O ARENA 120 KG NO SE RECOMIENDAN LAS VOLCADAS Y LOS JUEGOS PELIGROSOS.

RESISTENTE A LA INTEMPERIE

REF: SBA025S



CON POSTE



SIN POSTE



TABLERO

ALTURA : 2.30 A 3.05 M AJUSTE TRASERO

DIÁMETRO ARO: 45 CM EN ACERO DE 18 MM

MEDIDA TABLERO: 180 X 105 CM HASTA 150 M

MATERIAL: MARCO DE ALUMINIO Y VIDRIO
TEMPERADO DE 12 MM

POSTE: 1 PIEZA EN ACERO 152 MM. ALTURA 1.5M
RESISTENTE A LA INTEMPERIE

REF: SBA029TG - SIN POSTE
SBA029 - CON POSTE

TABLERO CON POSTE

ALTURA: 3.05 M POSTE PLEGABLE

DIÁMETRO ARO: 45 CM EN ACERO DE 19 MM

MEDIDA TABLERO: 180 X 105 CM X 12 MM

POSTE: 3 TUBOS DE ACERO DE 90 MM

BASE: 195 X 100 X 0.8 M

INCLUYE RUEDAS EN LA BASE

NET DE NYLON. RESISTENTE A LA INTEMPERIE

REF: SG-1



CON POSTE

TABLERO

ALTURA : 2.30 A 3.05 M TORNILLO JACK ADJUSTABLE

DIÁMETRO ARO: 45 CM EN ACERO DE 16 MM

MEDIDA TABLERO: 136 X 80CM

MATERIAL: VIDRIO TEMPLADO CON PE

POSTE: 3 PIEZAS DE ACERO DE 100 X 100 MM

BASE: 135 X 82 X 20 CM MOLDE SOPLADO EN PE.

CARGA 160 LTS DE AGUA

NET DE NYLON. RESISTENTE A LA INTEMPERIE

REF: SBA027 (CON POSTE)

REF: SBA027TG (SIN POSTE)



TABLERO CON POSTE

ALTURA : 2.30 A 3.05 M LEVANTAMIENTO DE POTENCIA

DIÁMETRO ARO: 45 CM EN ACERO DE 16 MM

MEDIDA TABLERO: 110 X 75 CM

MATERIAL: ACRÍLICO ENMARCADO EN PE

POSTE: 3 TUBOS DE ACERO DE 76 MM

BASE: 118 X 78 X 20 CM MOLDE SOPLADO EN PE.

CARGA 125 LTS DE AGUA

NET DE NYLON. RESISTENTE A LA INTEMPERIE

REF: SBA020



ARO

INCLUYE RED
REF: S-R2S



ARO CON RESORTE

INCLUYE: TORNILLOS PARA ANCLAJE Y NET
REF: S-R4



NET

2MM
REF: RBN10 - RWB - TRICOLOR
RBN10 - WT - BLANCA



RED SUPERIOR

REF: RKN7C102
ESTA RED CUMPLE CON EL ESTÁNDAR DE 12 BUCLES,
PATRÓN DE REJILLA DE 7 FILAS Y 20" DE LONGITUD.
IDEAL PARA BALONES DE BALONCESTO ESTÁNDAR.

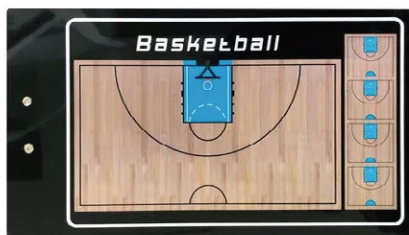

TABLERO DE COACH PARA BASKETBOL

REF: 8369

TABLERO MAGNÉTICO 40 X 24 CM
INCLUYE PLUMAS BORRADOR Y
14 IMANES QUE REPRESENTAN A LOS
JUGADORES, EL ÁRBITRO Y EL BALÓN.



TABLERO DE COACH PARA BASKETBOL

REF: RCBY14B

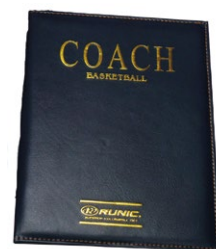



RVBV900

PVC
MEDIDA Y PESO OFICIAL



RV5U200

TEAM SPORT SERIES
PU TERMOLAMINADO
MEDIDA Y PESO OFICIAL



RVBV600

PVC COSIDO
PLAYA SOFT TOUCH
MEDIDA Y PESO OFICIAL



RV5U360

PU LAMINADO A MANO
OLÍMPICO
MEDIDA Y PESO OFICIAL



RV5UY10

100% PU



RV5V700

PVC TERMOLAMINADO
SOFT TOUCH
MEDIDA Y PESO OFICIAL



RV5U400

PU SUPER SOFT TOUCH
PROFESIONAL
VULCANIZADO
FIVB
MEDIDA Y PESO OFICIAL



RV5UY25

100% PU



RV5U800

PU
MEDIDA Y PESO OFICIAL



RV5U990

100% PVC
LAMINADO
SUPER SOFT TOUCH



RV-220SS

JAPAN PU
PROFESIONAL
LAMINADO
FIVB SUPER SOFT TOUCH



RVBV950



RVBV960



RVBV980

PVC
MEDIDA Y PESO OFICIAL



RODILLERA ACOLCHADA

REF: RKP650 WT
RKP651 RD
RKP652 RY
RKP653 BK

RODILLERA BÁSICA

REF: RKP654 WT
RKP655 RD
RKP656 RY
RKP657 BK



RODILLERA ACOLCHADA ELITE

REF: RKP3W111 BK



CODERA ACOLCHADA ELITE

ALMOHADILLA DE PUNTO DE ESPUMA FLEXIBLE QUE SE DESLIZA FÁCILMENTE EN LOS CODOS PARA PROTEGER DE QUEMADURAS DE SUELO Y MORETONES DURANTE EL JUEGO.

PERFECTAS PARA SU USO EN SUPERFICIES DURAS DONDE SE HACE CONTACTO REPETIDO DEL CODO AL SUELO.

AYUDA DE APOYO PARA LA PREVENCIÓN DE LESIONES, PERFECTA PARA TODAS LAS EDADES Y NIVELES, PRINCIPIANTE A AVANZADO.

INCLUYE DOS (2) CODERAS LAVABLES A MÁQUINA

REF: REP3W001

COLOR: NEGRO

JR

REF: REP3W171

COLOR: NEGRO

ADULTO

NET VOLEIBOL



REF: RVN7C611
957X97 CM
HILO PE 2MM
MALLA 10X10CM
BANDA SUPERIOR DE 5CM EN PVC
LAMINADO, CON CABLE DE ACERO
RECUBIERTO DE 4 MM DE DIÁMETRO



REF: RVN7C806
970X105 CM
HILO PE ROSCADO 2MM
MALLA 10X10 CM
BANDA SUPERIOR DE 4CM EN
PVC CON CABLE DE ACERO
RECUBIERTO 3MM



REF: RVN7C614
952X100 CM
HILO PE 3MM,
MALLA 9.5X9.5 CM
BANDA SUPERIOR DE TELA 5CM
BANDA LATERAL E INFERIOR 4CM
PVC NEGRO
CABLE DE ACERO REVESTIDO
DE 3 MM



VOLEIBOL

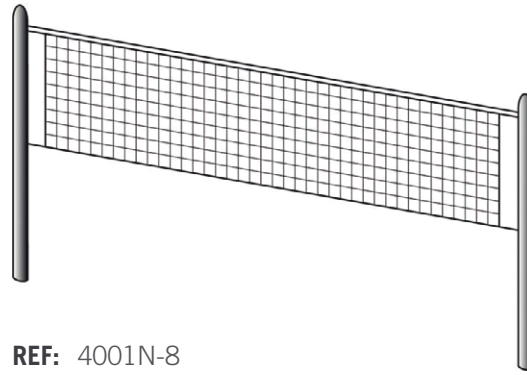

REF: 4001N-8
992X105 CM
HILO PE 2MM,
MALLA 9.5X9.5 CM
BANDA SUPERIOR, LATERALES
E INFERIOR 4CM PVC NEGRO
CABLE DE ACERO REVESTIDO DE 3 MM

REF: T4001N
968X97 CM
HILO 2MM,
MALLA 9.5X9.5 CM
BANDA SUPERIOR, LATERALES E INFERIOR
4CM PVC NEGRO
CABLE DE ACERO REVESTIDO DE 3 MM

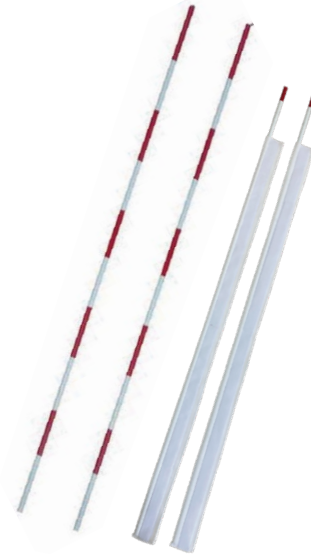

ANTENA VOLEIBOL

180 x 1 cm

REF: JPPG1 **PAR**

REF: 8113 **UNIDAD**



GORRA DEPORTIVA PERSONALIZABLE

100% POLYESTER
REF: GOLF



GORRA DEPORTIVA PERSONALIZABLE

100% LANA
REF: AC100



GORRA CLASSIC

UV UPF 50+
MESH Y MALLA
REF: CLASSIC

TALLA SM ML



GORRA PRO MESH

UV UPF 50+
100% COOL MESH
REF: PROMESH

TALLA SM ML



RAFW360 #9



RAFW120PW #6
PU



RAFKR52JR #6
CAUCHO
TAMAÑO OFICIAL JR



RAFW240JR #6
PU



RH3UD15 #3

PU
COSIDA



KICKBALL

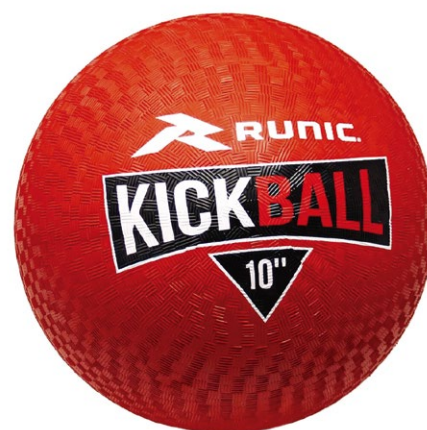

RKB10

100% CAUCHO



RW4R200 #4

WATER POLO
CAUCHO
VULCANIZADO
COMPETENCIA
MEDIDA Y PESO OFICIAL



SET RAQUETAS

INCLUYE: 4 RAQUETAS, 3 BOLAS,
POSTES Y NET
REF: RTT923



RAQUETA

REF: RTT336



SET RAQUETAS

INCLUYE: 2 RAQUETAS, 3 BOLAS,
POSTES Y NET
REF: RTT014



FORRO DE RAQUETAS DLX

REF: RTT798 -BK/RD
RTT798 - GY/BL



SET RAQUETAS

INCLUYE: 2 RAQUETAS, 2 BOLAS
REF: RTT207



SET DE RED Y POSTES PING PONG

REF: RTT981



RED Y POSTE SUPERIOR

REF: RTT002



RED

REF: RTT538



BOLA PING PONG

PELOTAS PARA COMPETENCIA
40MM.

ALTA CALIDAD

IDEAL PARA TORNEOS

TAMAÑO Y PESO OFICIAL

MATERIAL: 100% ABS

COLOR: BLANCO Y NARANJA

6 UNID.

REF: RTT7G00-WT

RTT7G00-OR



PROTECTOR DE MESA PING PONG

INDOOR

REF: RTTC01



MESA DE PING PONG SMASH

2 CARROS SEPARADOS
CON RUEDAS

MUY ROBUSTA Y TERMINACIÓN
IMPECABLE
FUNCIÓN FRONTÓN

REF: R201B



 **USO
INDOOR**



SOBRE DE
18MM MDF



MARCO DE
15X30MM



TREN DE
30X30MM



RED Y POSTES
INCLUIDOS



FÁCIL Y SEGURO
AL MOMENTO
DE ABRIR Y CERRAR

4 RUEDAS DE PLÁSTICO DE
Ø200, (2 CON FRENO
Y 2 SIN FRENO).



COMPARTIMENTO
PARA ALMACENAR
RAQUETAS Y BOLAS



MESA DE PING PONG BÁSICA CON RUEDAS

DIMENSIONES: 274 X 152.5 X 76 CM

PESO (MESA): 70 KG

8 RUEDAS DE PLÁSTICO DE Ø50 MM,
4 CON FRENO.

INCLUYE: RED Y SOPORTES

REF: R610B



 **USO
INDOOR**



**SOBRE DE
15 MM MDF**



**MARCO DE
15X23MM**



**TREN DE
30X30MM**



**RED Y POSTES
INCLUIDOS**



**FÁCIL Y SEGURO
AL MOMENTO
DE ABRIR Y CERRAR**

MESA DE PING PONG

DIMENSIONES: 274 X 152.5 X 76 CM

SUPERFICIE EN FIBRA VULCANIZADA
DE ALTO REBOTE Y EXCELENTE
TERMINACIÓN

PESO (MESA): 70 KG

FUNCIÓN FRONTÓN

MUY ROBUSTA Y TERMINACIÓN
IMPECABLE

REF: R622B



 **USO
INDOOR**



**SOBRE DE
15MM MDF**



**MARCO DE
15X30MM**



**TREN DE
30X30MM**



**RED Y POSTES
INCLUIDOS**



MESA DE PING PONG REVOLUTION

DIMENSIONES: 274 X 152.5 X 76 CM
 SUPERFICIE EN MDF 18MM
 2 CARROS SEPARADOS
 MUY ROBUSTA Y TERMINACION IMPECABLE
 FUNCIÓN FRONTÓN

REF: R888B



 **USO
INDOOR**



**SOBRE DE
18 MM MDF**



**MARCO DE
15X30MM**



**RED Y POSTES
INCLUIDOS**

MESA DE PING PONG OUTDOOR

DIMENSIONES: 274 X 152.5 X 76 CM
PESO (MESA): 55 KG
 INCLUYE RED Y SOPORTES
REF: R019SB



 **USO
OUTDOOR**



**SOBRE DE
4MM ACP**



**MARCO DE
15X30MM**



**TREN DE
30X30MM**



**RED Y POSTES
INCLUIDOS**



**FÁCIL Y SEGURO
AL MOMENTO
DE ABRIR Y CERRAR**



**4 RUEDAS DE PLÁSTICO DE
Ø200, (2 CON FRENO
Y 2 SIN FRENO).**



**COMPARTIMENTO
PARA ALMACENAR
RAQUETAS Y BOLAS**



MESA DE PING PONG CON RUEDAS

DIMENSIONES: 274 X 152.5 X 76 CM

PESO (MESA): 70 K

REF: R018B



 **USO INDOOR**



FÁCIL Y SEGURO AL MOMENTO DE ABRIR Y CERRAR

4 RUEDAS DE PLÁSTICO DE Ø200, (2 CON FRENO Y 2 SIN FRENO).

COMPARTIMENTO PARA ALMACENAR RAQUETAS Y BOLAS

MESA DE PING PONG DLX

DIMENSIONES: 274 X 152.5 X 76 CM

PESO (MESA): 102 KG

REF: R802B



 **USO INDOOR**



FÁCIL Y SEGURO AL MOMENTO DE ABRIR Y CERRAR

4 RUEDAS DE PLÁSTICO DE Ø200 CON FRENO.

COMPARTIMENTO PARA ALMACENAR RAQUETAS Y BOLAS



BADMINTON



PLUMA DE ENTRENAMIENTO

12 UNIDADES
REF: 9



RED PARA BADMINTON

REF: BN-37010
COLOR: :Blanco / Rojo
CABLE DE 76 X 6,1 M



REF: K-2058 COLOR: AMARILLO NEÓN



REF: K-2058 COLOR: NARANJA NEÓN



REF: K-7700 COLOR: VERDE



REF: K-7703 COLOR: VERDE



REF: K-227 COLOR: VIOLETA



REF: K-227 COLOR: NEGRO

RAQUETA DE BADMINTON BÁSICA CON FORRO 1 PAR



RAQUETA PICKLEBALL ACTIVATOR

REF: 52740



BOLA PICKLEBALL X 40

3 PZAS

REF: 52821



RAQUETA PICKLEBALL PILOT

REF: 52771



RAQUETA PICKLEBALL X1000

REF: 52772



CASCO DE CICLISMO

DISEÑO AERODINÁMICO LIVIANO, PARA MAYOR COMODIDAD.

CORREAS AJUSTABLES

VISERA REMOVIBLE

CANALES DE VENTILACIÓN

MATERIAL: 20% POLICARBONATO – 80% FOAM.

REF: BHK15-1



TABLAS DE NATACIÓN

IDEALES PARA EL APRENDIZAJE Y ENTRENAMIENTO DE NIÑOS Y ADULTOS.
AYUDA A PERFECCIONAR LA TÉCNICA DE NADO Y LA FLOTABILIDAD
NO ABSORBEN AGUA, ALARGANDO LA VIDA DEL PRODUCTO Y LA HIGIENE.



REF: RYP03A
TAMAÑO: 38 x 25 CMS



REF: SB8018
TAMAÑO: 41 x 28 CM
MATERIAL: ESPUMA EVA COMPRIMIDA DE ALTA CALIDAD.
COLORES: VARIADOS



REF: SB8016F
TAMAÑO: 41 x 28 CMS
COLOR: AZUL, ROSADO
CON AGARRE INCLUIDO



REF: SB8014
TAMAÑO: 42 x 29 CMS
COLORES: VARIADOS



REF: SB8017
TAMAÑO: 39 x 31 CM
MATERIAL: ESPUMA EVA COMPRIMIDA DE ALTA CALIDAD.
COLORES: VARIADOS



REF: SB8019
TAMAÑO: 42 x 31 CM
MATERIAL: ESPUMA EVA COMPRIMIDA DE ALTA CALIDAD.
COLORES: VARIADOS



REF: RYP02
TAMAÑO: 40 CMS



GORRA PARA NATACIÓN

REF: RSIL800
COLOR: AZUL, NEGRO, SILVER
MATERIAL: SILICONE



FLOTADOR PIERNA PULL BOY

REF: RYP26 - JUNIOR
RYP26A - ADULTO



CHALECO SALVAVIDA

REF: RLV2Y200

TALLA S M L XL XXL

TUBO FLOTADOR

REF: RPN16
COLORES: VARIADOS





COMBO DE BUCEO JR

REF: SET8A



COMBO PLAYERO

REF: SET7A



BASTÓN DE RELEVO

SET DE 8 PIEZAS
REF: CT1-1



BASTÓN DE RELEVO

3.8 CM - 8 COLORES
REF: X-1405-T



DISCO DE ATLETISMO

REF: 1523 **COLOR:** Rojo **1KG**
REF: 1431 **COLOR:** Rojo **1,5KG**
REF: 1433 **COLOR:** Verde **2KG**



DISCOS

REF: T1011 - 1.0 Kg
T1011A - 1.5 Kg
T1175 - 1.75 Kg
T1012 - 2.0 Kg



BALA

REF: T10 - 10LB T14 - 14LB
T12 - 12LB 3686 - 7 2.7K



BLOQUE DE PARTIDA

REF: J-QPQ-1



JABALINA

REF: JAB600 - 600gr
JAB700 - 700gr
JAB800 - 800gr



JABALINA DE ENTRENAMIENTO

REF: 600GR-3 - 600gr - Verde
600GR-3 - 600gr - Morado



SET DE BOLAS DE BILLAR

12 PZAS

REF: BLD-1



PALO DE BILLAR

2 PZAS

REF: BLD-8



TRIÁNGULO PARA BILLAR

MATERIAL: PLÁSTICO

REF: BLD-4



TRIÁNGULO PARA BILLAR

MATERIAL: MADERA

REF: BLD-5



TIZA PARA BILLAR

12 PZAS

REF: BLD-9



TABLERO DE AJEDREZ

MEDIDAS: 50x50 CMS

REF: CH5050



TABLERO DARDOS

DIÁMETRO 17"
REF: 17115
INCLUYE DARDOS



SET 6 DARDOS

REF: BL-6008

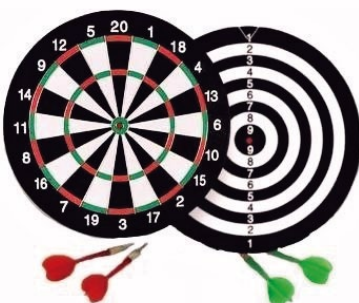

TABLERO DARDOS

DIÁMETRO 15" / 29 CM
REF: 15115
INCLUYE DARDOS



SET DE DOMINÓ

REF: 5412



JUEGO DE 3 DARDOS

3 DARDOS
REF: BL-3021A



SET DE DOMINÓ

12MM
REF: DOM12



SET DE 5 OBSTÁCULOS PARA ENTRENAMIENTO

REF: RHU9Y500

OBSTÁCULOS AJUSTABLES DE 8" A 12".

APTO PARA ENTRENAMIENTOS DE VELOCIDAD Y PRECISIÓN.



SET DE OBSTÁCULOS

REF: HCRHC1812

SET DE 2 CONOS DE 18" DE ALTURA Y 1 BARRA DE 1 M DE LARGO.



SET DE 6 CONÓS HELIX

REF RC93Y836



SET DE 10 CONOS 2" PRO

REF RC23Y102



CONO PLANO 2" TIPO PLATO

REF PRO2 - OR
POR UNIDAD



SET DE 10 CONOS PLÁSTICOS 2"

REF RCS9Y102



SET DE 50 CONOS PLANOS 2" TIPO PLATO

50 UNID 10 x COLOR
INCLUYE GANCHO PARA GUARDAR
Y TRANSPORTAR
REF R6050



CONOS PLÁSTICOS

REF PRO 7 - 7" / 17.8 cm
PRO 9 - 9" / 22.8 cm
PRO12 - 12" / 30.5 cm
PRO15 - 15" / 38 cm
PRO18 - 18" / 45.7 cm

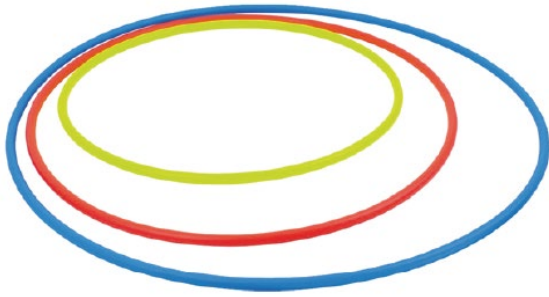

HULA HOOP CILÍNDRICO

REF	HH450	45 CM	AMARILLO
	HH550	55 CM	ROJO
	HH650	65 CM	AZUL
	HH750	75 CM	VERDE
	HH850	85 CM	ROJO

POR UNIDAD

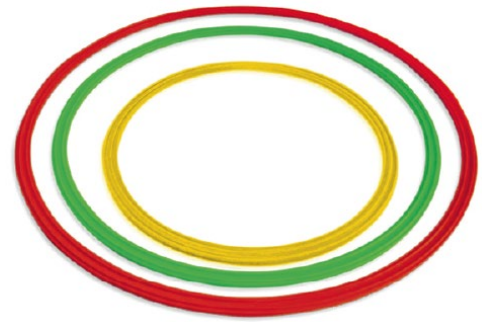

HULA HOOP PLANO

REF	FR400	40 CM	AMARILLO
	FR500	50 CM	VERDE
	FR600	60 CM	ROJO

POR UNIDAD



SET DE 6 AROS DE AGILIDAD

REF RAR3Y050
MEDIDAS 50 CM



SET DE 4 AROS DE AGILIDAD

REF RAR3Y840
MEDIDAS 40 CM



ESCALERA DE AGILIDAD

REF RAL3Y236
MEDIDAS 6 M / 20"

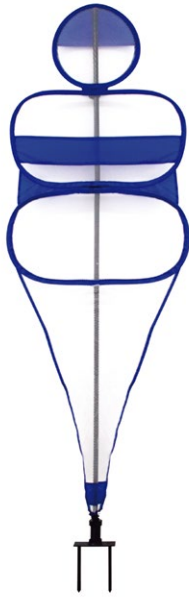

DEFENSA PARA FÚTBOL

REF: RFKW165
MEDIDAS: 160 X 2.5 CM
MATERIAL: METAL
INDIVIDUAL



DEFENSA PARA FÚTBOL INFLABLE

REF: RFKW180P
MEDIDAS: 180 X 51 CM
MATERIAL: PVC
INDIVIDUAL

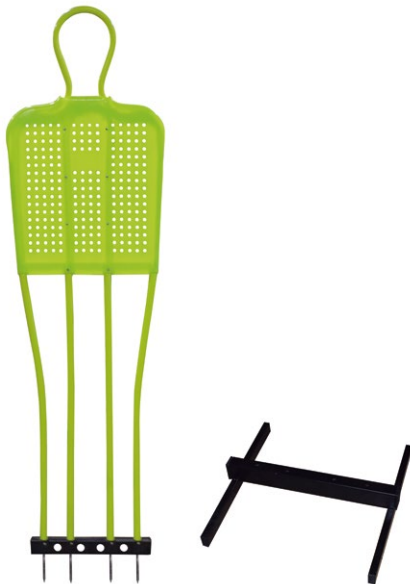

DEFENSA PARA FÚTBOL

REF: FKW04
REF: FKW04-BASE
MEDIDAS: 180 X 51 CM
MATERIAL: PLÁSTICO
INDIVIDUAL



POSTE DE AGILIDAD CON BASE

REF: RM12291
MEDIDAS: 160 X 2.5 CM
INDIVIDUAL



TRAMPOLÍN 40"

MEDIDAS: 100 CM DIA. x 20 ALT. CM
6 PATAS DE 18 CM x 2.5CM CON GOMA
ANTIDESLIZANTE
MARCO CIRCULAR 1" x 1" HIERRO ESMALTADO
MALLA POLIPROPILENO NEGRO RESISTENTE
RAYOS UV
RESORTES DIÁMETRO EXTERIOR 1,8 CM
/ ACERO GALVANIZADO
CAPACIDAD MÁXIMA: 90 KILOS
REF: HL-2064

A.



B.



STEP PARA AERÓBICOS

- A. MEDIDAS:** 110 x 36 x 20 CM
REF: STP-T015
- B. MEDIDAS:** 70 x 30 x 15 CM
REF: 1210S



COLCHONETA PARA EJERCICIO

REF: 1

MATERIAL: PVC ACOLCHADO.
ANTIBACTERIAL

MEDIDA: 173 x 61 cm

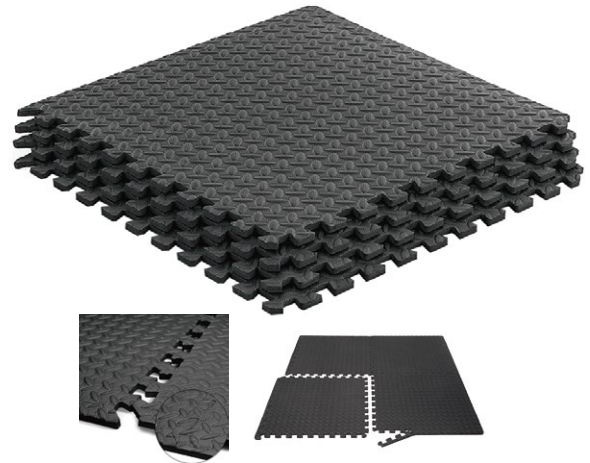

SET DE 4 INTERLOCKING MAT

REF: RPMOT612

MATERIAL: EVA FOAM

MEDIDA: 61 x 61 x 1.2 CM

4 PIEZAS



COLCHONETA PLEGABLE DLX

REF: EM-12D

MATERIAL: PVC, ACOLCHADA
ALTA RESISTENCIA

MEDIDA: 180 x 60 x 4 cm

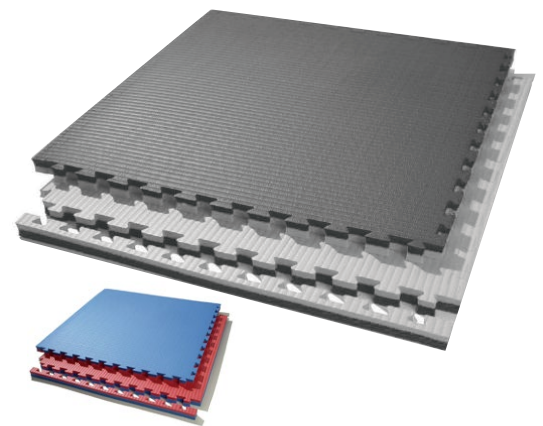

COLCHONETA PARA ARTE MARCIAL TATAMI

REF: RMTKD1001 - BK/GY
RMTKD1001 - BL/RD

MATERIAL: FOAM

MEDIDA: 100 x 100 x 2 CM
INDIVIDUAL



PISO DE CAUCHO PARA GIMNASIOS

VERSÁTIL EN EL HOGAR, GIMNASIO, SALA DE JUEGOS, ENTRE OTROS

PROPORCIONA UN COJÍN A LAS SUPERFICIES DE PISOS DUROS EN SALAS DE JUEGOS, AULAS, GIMNASIOS Y MÁS.

PERFECTOS PARA EJERCICIO, GIMNASIA, YOGA, CROSSFIT, PILATES, MMA, ÁREAS DE JUEGO PARA NIÑOS, GUARDERÍAS, TALLERES, SALAS DE FITNESS.

LAS PIEZAS GRANDES, ACOLCHADAS SON SEGURAS; NO SOLO PARA LOS EJERCICIO, SINO TAMBIÉN PARA PROTEGER CONTRA DAÑOS EL SUELO.

SUPERFICIE DE ALFOMBRA ANTIDESLIZANTE CON PROPIEDADES DE AMORTIGUACIÓN EXCEPCIONALES.

AMORTIGUADOR DE IMPACTO Y SONIDO.

HECHO DE CAUCHO LO QUE OFRECE UNA MAYOR DURABILIDAD.

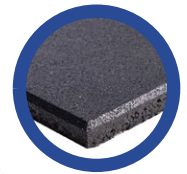

PISO DE CAUCHO

MEDIDA: 50 x 50 x 1.5 CM

REF: RTH05015

INDIVIDUAL



PISO DE CAUCHO INTERCONECTABLE

REF: RF2W50501

MATERIAL: CAUCHO

MEDIDA: 50 x 50 x 1 CM

4 PIEZAS



PROTECTOR BUCAL SENCILLO

INCLUYE ESTUCHE

REF: MGGA001
MGGA001 - JR



PROTECTOR BUCAL DOBLE

INCLUYE ESTUCHE

REF: MGGA002
MGGA002 - JR



PROTECTOR BUCAL

INCLUYE ESTUCHE

REF: 5917-0001 - NEGRO
5917-0301 - VERDE NEON



HAND GRIP AJUSTABLE

RESISTENCIA: 10 A 40 KG

REF: RHGOW90



HAND GRIP

MANGO PLÁSTICO

REF: HG01B2



HAND GRIP

MANGO FOAM

COLORES: BL / NYW / PK

REF: HG02B2



GUANTE DE PESAS HAMMER

REF: RWG3H100

TALLA S M L XL



MUÑEQUERA SURTIDA

REF: RWB4

COLORES: NEGRO, NAVY, ROJO



SUSPENSORIO CON COPA

REF: RSC5K72

TALLA YM YL - S M L XL



TRAJE PARA SAUNA

REF: KD788

DOS PIEZAS LIGERAS DE PVC SUAVE. CUELLO, PUÑOS, CINTURA CON ELÁSTICOS PARA UN MEJOR AJUSTE. GENERA Y RETIENE EL CALOR DURANTE EL ENTRENAMIENTO. FÁCIL LAVADO CON AGUA.

TALLA XL XXL



FAJA DE NEOPRENO

REF: RWB610 10"
RWB612 12"

COLORES: NEGRO, NAVY

SE AJUSTA DE FORMA NATURAL AL CUERPO CIERRE DE VELCRO GENERA Y RETIENE EL CALOR DURANTE EL ENTRENAMIENTO AYUDA A LA POSTURA Y ESPALDA BAJA



MEDIAS DE COMPRESIÓN

REF: 860-002 COLOR: ROJO

TALLA M L

FAVORECEN EL RETORNO SANGUÍNEO Y LA OXIGENACIÓN DE LA SANGRE Y EN CONSECUENCIA AUMENTA EL RENDIMIENTO DEL DEPORTISTA. ADEMÁS, TIENEN OTROS BENEFICIOS COMO REDUCIR LA VIBRACIÓN DEL MÚSCULO, EVITAR ROZADURAS Y PREVENIR EL MOVIMIENTO LATERAL DE LOS GEMELOS. ESTÁN FABRICADAS EN NYLON Y LYCRA CON COSTURA DE ÚLTIMA TECNOLOGÍA. C.R.E.C SYSTEM (CONJUNTO DE RECUPERACIÓN DE ENERGÍA CORPORAL)



PORTA BOTELLAS

REF: J2CB875

CAPACIDAD: 8 UNIDADES

COLOR: AZUL

MATERIAL: PLÁSTICO



MALETÍN DUFFLE

REF: RDB9B002 NAVY / RED
TAMANO: 60 x 30 x 28 cm



PORTA TACOS

REF: RSB061 NAVY / RED.
RSB062 BLACK / ORANGE

TAMANO: 36 x 17 x 18 cm





BOLSO DE BALONES

REF: RBB600

CAPACIDAD: APROX. 20 BALONES #5



CARRITO PARA TRANSPORTAR BALONES EN CANCHA

REF: RKT3Y886

ALTURA TOTAL: 90 CMS

TAMAÑO CESTA: 65 X 65 X 45 CMS



CARRO DISPENSADOR DE BALONES

REF: RBC8M200

TAMAÑO: 127 x 56 x 29 cm

CARRITO DEPORTIVO PORTÁTIL PLEGABLE. FABRICADO EN ACERO CROMADO DE ALTA RESISTENCIA.

FUNDA FABRICADA EN NYLON REFORZADO. ADECUADO PARA TODO TIPO DE BALONES. PORTÁTIL CON RUEDAS.



RED PARA BOLAS

T4029N

CAPACIDAD: APROX. 20 BOLAS #5



BOMBA DE INFLAR

REF: RPB3Y162



TABLÉRO DE ANOTACIÓN SCORE

REF: 70036B

DIMENSIONES: 53 X 25 cm

FÁCIL DE USAR; PLEGABLE Y TRANSPORTABLE.



TABLÉRO DE ANOTACIÓN SCORE

REF: 70036A



CRONÓMETRO 10 MEMORIAS

REF: JS506

RÁPIDO REINICIO CALENDARIO Y RELOJ

ALARMA DIARIA PEDÓMETRO

RESISTENTE AL AGUA

INCLUYE BATERÍA



CRONÓMETRO SENCILLO

REF: JS307

DIGITAL CON CORDÓN, RÁPIDO REINICIO

CALENDARIO Y RELOJ, ALARMA DIARIA

PEDÓMETRO

INCLUYE BATERÍA



SILBATO PLÁSTICO

REF: CY318

12 UNID.



PITO PLÁSTICO CON CORDÓN

REF: PW6L

INDIVIDUAL



SILBATO CON CORDÓN

REF: RWH9Y001



CORDÓN PARA SILBATO 10 UNID

REF: LAN7R77



MEDIDOR DE PRESIÓN DIGITAL FOX 40®

REF: 6906-0200

ASEGURA LA PRESIÓN DE AIRE EXACTA, PARA CUALQUIER BOLA INFLABLE. DISEÑADO CON UNA VÁLVULA DE AIRE DE LIBERACIÓN RÁPIDA, QUE PERMITE QUE EL AIRE SE DESCARGUE SIN QUITAR EL PASADOR O EL CALIBRE DE LA BOLA, LO QUE GARANTIZA QUE LAS BOLAS INFLADAS DE FORMA EXCESIVA OBTENGAN UNA PRESIÓN DE AIRE INMEDIATA Y ABSOLUTAMENTE PRECISA. OPCIONES DE PSI, BAR, KG Y KPA DISPONIBLES. EL MODO PREDETERMINADO ES PSI. LOS PASADORES ESTÁN HECHOS DE ALEACIÓN DE ZINC. **INCLUYE:** 2 AGUJAS DE REPUESTO.



KIT SPORT FOX 40®

REF: 6906-0000

INCLUYE: SILBATO PEALESS FOX 40® CLASSIC® (115 DB), INFLADOR Y 3 AGUJAS.



KIT FOX 40®

REF: 6906-0600 GN

INCLUYE: INFLADOR, PITO Y RELOJ



INFLADOR

REF: RM-40E

DOBLE ACCIÓN (INFLA Y DESINFLA)
INCLUYE AGUJA



BOMBA DE INFLAR CON MEDIDOR

REF: YB062

ACERO INOXIDABLE
PARA TODO TIPO DE VÁLVULA



BOMBA DE INFLAR

REF: YB061

PLÁSTICA PARA TODO TIPO DE VÁLVULA



PITO SONIK CMG®

REF: 9200-0008

POTENCIA DE SONIDO 120 DB

DISÑO 2 CÁMARAS + CMG

EL FOX 40 SONIK BLAST® CMG® ES EL MÁS EFICIENTE SILBATO EN SU CLASE. BOQUILLA AMORTIGUADA EN MATERIAL TERMOPLASTICO QUE PROPORCIONA AGARRE SUPERIOR Y PROTECCIÓN DE LOS DIENTES. DISTINGUIDO, FUERTE Y SONIDO CLARO AL OÍDO HASTA 1 MILLA DE DISTANCIA. EL MODELO FINGERGRIP SE AJUSTA DE FORMA SEGURA Y CÓMODA SOBRE EL GRUPO DE DEDOS



PITO CLASSIC CMG®

REF: 9600-0008

POTENCIA DE SONIDO 115 DB

DISÑO: 3 CÁMARAS SIN GAS + CMG

IDEAL PARA AQUELLOS CON LA NECESIDAD DE SOSTENER EL SILBATO EN LA BOCA POR AMPLIOS PERÍODOS DE TIEMPO. EL MATERIAL TERMOPLÁSTICO AMORTIGUADO DE LA BOCA (CMG) PROPORCIONA UN AGARRE Y UNA PROTECCIÓN SUPERIOR PARA LOS DIENTES.



PITO MINI CMG®

REF: 9400-0008

POTENCIA DE SONIDO 109 DB

DISÑO: 3 CÁMARAS + CMG

EL FOX 40 MINI CMG ES UNA VERSIÓN MÁS COMPACTA DEL FOX 40 CLASSIC CMG CON UNA BOQUILLA MÁS PEQUEÑA EL MATERIAL TERMOPLÁSTICO AMORTIGUADO DE LA BOCA (CMG) PROPORCIONA UN AGARRE Y UNA PROTECCIÓN SUPERIOR PARA LOS DIENTES. PRODUCE UN TONO AGUDO Y ULTRA-ESTRIDENTE





PITO FOX 40® SAFETY

REF: 9702-0008 BK 9702-0108 RD
 9702-0508 BL 9702-1308 YW
 9702-1408 GN

POTENCIA DE SONIDO 90 DB

DISENO: 2 CÁMARAS

LA FOX 40® PEARL™ TIENE UN TONO DIFERENTE, ES IDEAL PARA JUEGOS MULTI-CAMPO. PERFECTO PARA LOS QUE NECESITAN SILBATO SONANTE Y PENETRANTE, QUE OPAQUE EL RUIDO AMBIENTAL

PITO FOX 40® CLASSIC

REF: 9902-0000 BK 9902-0100 RD
 9902-0500 BL 9902-1300 YW
 9902-1400 GN

POTENCIA DE SONIDO 115 DB

DISENO: 3 CÁMARAS

EL FOX 40® CLASSIC™ IDEAL PARA LOS ARBITROS Y ENTRENADORES DE TODO NIVEL, ES UN SILBATO IMPECABLE, CONSISTENTE Y FIABLE. ALCANDE DE 1 MILLA DE DISTANCIA. EL MODELO FINGERGRIP SE AJUSTA DE FORMA SEGURA Y CÓMODA SOBRE EL GRUPO DE DEDOS



PITO FOX 40® XPL LIGHT Y MICRO NEON

REF: 7918-1400 GN



KIT PITO FOX 40® 3 PACK

REF: 6906-0500 BK



PITO CLASSIC CMG

REF: 9602-0000



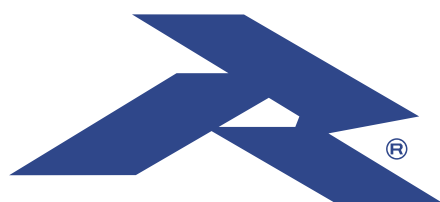

PARA MAYOR INFORMACIÓN CONTACTE A SU EJECUTIVO DE VENTAS

DEPORTES JIMMY CR S.A
Ofibodegas Capri, Bodega #20, de Multiplaza Escazú, 1 km al norte,
contiguo al Colegio Blue Valley. Guachipelín.
San José. Costa Rica

C: ventascr@djimmy.net

W: (506) 7012 4297

T: (506) 2215 1578
(506) 2215 1745



@runic.cr