



**FITNESS
ACCESSORIES**



EVERLAST®
F.I.T.

FITNESS ACCESSORIES



*each weight 1.5 lbs (3 lbs total)



*each weight 3 lbs (6 lbs total)

WRIST WEIGHTS

Fully adjustable.
Perfect for toning and aerobic exercises
A contoured and velcro strapped design to provide a custom fit for your ankles and/or wrists.
Balanced weight for better balance.
Durable construction.

SKU: EVWW3W003 **Color:** Purple **1.5LB PAIR**
SKU: EVWW3W006 **Color:** Blue **3LB PAIR**



*each weight 1 lbs (2 lbs total)



*each weight 2.5 lbs (5 lbs total)

PREMIUM ANKLE/WRIST WEIGHTS

Fully adjustable.
Burn more calories during activity with F.I.T. 5 & 2 lbs Comfort Weights.
An adjustable, contoured design provides a custom F.I.T. for your ankles and/or wrists.
A soft terry cloth interior absorbs moisture and is completely non-abrasive.
Includes two weights: each weight is 2.5 lbs (5 lbs weights) or 1 pound (2 lbs weights).

SKU: P00000741 **Color:** Purple **2LB PAIR**
SKU: P00000742 **Color:** Blue **5LB PAIR**





FITNESS ACCESSORIES



ANKLE WEIGHTS

Fully adjustable.
Burn more calories.
Comfort weights for your ankles.
Adjustable, contoured design provides a custom fit.

SKU: EVWW0W016	Color: Black / Red	8lbs	16LB PAIR
SKU: EVWW0W020	Color: Black	10lbs	20LB PAIR



1 LB

2.5 LB

5 LB

ANKLE/WRIST WEIGHTS

Precision weighted and balanced.
Durable construction.
Comfortable neoprene coating.
Perfect for aerobics and toning.

SKU: EVWW610	Color: Purple	2lbs / 1lb each	2LB PAIR
SKU: EVWW625	Color: Blue	5lbs / 2.5lb each	5LB PAIR
SKU: EVWW650	Color: Black	10lbs / 5lb each	10LB PAIR

FITNESS ACCESSORIES



HAND WEIGHT ERGONOMIC

This hand shaped design, allows you to grip the weight slightly without having to over squeeze. Great for any kind of workout that use light weighted weights, walking, jogging and aerobics. Increase the effectiveness of your workout with this pair of everlast 6lb / 10lb. Cardio weights.

SKU: EVWD1W130 **COLOR:** Purple **3LB**

SKU: EVWD1W250 **COLOR:** Dark Grey **5LB**



2LB
PAIR
(2 X 1LB WEIGHTS)



4LB
PAIR
(2 X 2LB WEIGHTS)

WALKING WEIGHTS

Comfortable and ergonomic 2lb / 4lb weights Fit comfortably in your palm. Durable enough to use for your everyday workouts. Improve cardio endurance, develop your Muscles and tone your entire body. Durable enough for your everyday workouts. Neoprene material is great for indoor and outdoor use. Soft grip makes them comfortable to hold for light cardio exercises. Compact and convenient to take when you travel.

SET OF TWO 2 LB WEIGHTS

SKU: EVWW1S20 **Color:** Black / Pink **2LB**
PAIR

SET OF TWO 4 LB WEIGHTS

SKU: EVWW1S40 **Color:** Blue / Lime **4LB**
PAIR





VINYL COATED DUMBBELLS

Precision Weighted And Balanced, Durable Construction.
Vinyl Coating For Added Comfort And Protection.
Perfect For Aerobics And Toning.

-
- SKU: EVDD02 - 2LB COLOR: Pink**
 - SKU: EVDD03 - 3LB COLOR: Violet**
 - SKU: EVDD04 - 4LB COLOR: Orange**
 - SKU: EVDD05 - 5LB COLOR: Red**
 - SKU: EVDD06 - 6LB COLOR: Purple**
 - SKU: EVDD07 - 7LB COLOR: Yellow**
 - SKU: EVDD08 - 8LB COLOR: Blue**
 - SKU: EVDD09 - 9LB COLOR: Green**
 - SKU: EVDD10 - 10LB COLOR: Charcoal**
 - SKU: EVDD12 - 12LB COLOR: Royal**
 - SKU: EVDD15 - 15LB COLOR: Black**



WEIGHTED FITNESS BAR

VERSATILE WORKOUT BAR

Our exclusive fitness equipment bar is designed to add strength, balance, and flexibility to your workouts, improving effectiveness during circuit and interval classes, kickboxing and martial.

WORKS GREAT FOR

- Gaining Range Of Motion
- Physical Rehabilitation
- Increasing Mobility
- Toning Muscles
- Burning Fat

SOLID STEEL CORE

Single piece construction

HIGH DENSITY PADDED FOAM SURFACE

Durable increased comfort and decreased slipping.



ANTI ROLL PLASTIC EN CAP



STURDY, RESILIENT CONSTRUCTION

Our durable exercise bar is designed with a one-piece, heavy-duty steel core, to prevent any breaking or bending, and rubber pads with a high-density interior for long-lasting use, taking pressure off hands.

Shape up and gain muscle definition. Perfect for many styles of fitness classes as well as any aerobics studio class. Add weight to standard bodyweight Exercises such as lunges and squats.



3 SKU: EVFB1W300
KG COLOR: Black / Yellow

5 SKU: EVFB1W500
KG COLOR: Black / Grey



FITNESS ACCESSORIES



SAUNA SUIT

MAXIMIZE CALORIE BURN AND DETOXYFY BODY WITH INCREASED PERSPIRATION

Excellent for aerobic conditioning.

Keeps muscles warm and helps to shed excess water.

Full cut for comfortable fit during activity.

Two piece outfit with elastic waist, cuffs, and ankles.

Made with heavy duty pvc fabric.

SKU: EVSS1S27 **COLOR:** Black **L XL XXL**

SKU: P00002713 **COLOR:** Black **XXL**

SKU: P00002712 **COLOR:** Black **L XL**



HOODED SAUNA SUIT

SHED WATER WEIGHT, TRAP HEAT, WARM UP MUSCLES

Designed to trap body heat and keep muscles loose.

Allowing you to shed excess water weight and calories.

More efficiently prior to or during a workout.

SKU: EVSH5S57 **COLOR:** Grey **L / XL - XL / XXL**



EVERLAST

FITNESS ACCESSORIES



ADJUSTABLE WEIGHT VEST

REFLECTIVE TAPE

A wide reflective tape on the back of the weight vest makes night exercising much safer.

ERGONOMIC DESIGN

Balanced weight is distributed throughout your body, including adjustable straps to prevent slipping during exercise.

EQUAL WEIGHT DISTRIBUTION

Balanced weight distribution and with pockets on the front and back of the vest, this weight vest can provide you with maximum comfort during all exercises without straining your back or shoulders.

SKU: EVAVOW020 Color: Camo

20KG

ENGINEERED FOR:

STRENGTH & SPORT SPECIFIC TRAINING
TOTAL BODY & CARDIO CONDITIONING



EVERLAST

FITNESS ACCESSORIES



20LB



10LB



WEIGHTED TRAINING VESTS

MADE WITH SOFT NEOPRENE MATERIAL FOR ULTIMATE COMFORT & DURABILITY. IDEAL FOR STRENGTH AND WEIGHT TRAINING, WEIGHT LOSS AND IMPROVING BONE DENSITY. ONE SIZE FITS MOST BODY TYPES.



REFLECTIVE TAPES

There are multi reflective tapes on both sides of the weight vest which make the night running much safer.

NEOPRENE MATERIAL

Made with soft breathable neoprene fabric with quality sand filling, which is super soft and helps to concentrate the weight in the chest and upper body during training and builds core muscle strenght.

EVENLY DISTRIBUTED WEIGHTS

Extra resistance evenly to body weights, it will not slip and slide during any activities.

CONVENIENT STORAGE POCKET

Mesh pocket to store belongings on the back of the weight best when running or walking.

SKU: EVVW0W620 COLOR: Black 20Lbs

SKU: EVVW0W610 COLOR: Grey 10Lbs

FITNESS ACCESSORIES



8lb WALKING FITNESS VEST

FOR MORE INTENSE WORKOUTS

Use For Walking And Sport Training

For More Intese Workouts

Improve Cardio And Strength, Speed And Agility

Comfortable Form-fitting Design

Reflective Stripes

FEATURING
EVERCOOL™
TECHNOLOGY

SKU: EVFV1S08 8Lbs **COLOR:** Yellow



FITNESS SET

COMPLETE WORKOUT

JUMP ROPE

For a fast, cardio, calorie burning workout

UPPER BODY POWER CORD

Tones abs, arms chest shoulders and back

WAIST TRIMMER BELT

Preserves body heat

Promotes water loss and provides back support

SKU: EVFS1S94

COLOR: Lime



FITNESS ACCESSORIES



75
cm

ANTI-BURST GYM BALL

Ideal for yoga, pilates, strength training, core training, stretching, toning and resistance exercises.

Product features

Helps improve balance, coordination and flexibility.

Ideal for core strength training, stretching, toning, resistance exercises.

Safe, durable and easy to use. Includes hand pump.

Use to strengthen and tone your hips, back, legs, and houlders without additional Stress on the spine or hips.

SKU: EVYB3W255 COLOR: Purple 55cm

SKU: EVYB3W065 COLOR: Grey 65cm

SKU: EVYB3W175 COLOR: Blue 75cm



65
cm



55
cm



SUPERIOR BALL

Deal for yoga exercises, pilates, basic training, stretching, toning and resistance.

Used to strengthen and tone your abdomen, hips, back and shoulders without stress.

Helps improve balance, coordination and flexibility.

Non-slip design, durable, easy to use and safe.

Includes manual pump to inflate.

100% pvc.

SKU: EVYB3W006 COLOR: Black

FITNESS ACCESSORIES



55
cm

ANTI-BURST GYM BALL

Ideal for yoga, pilates, strength training, core training, stretching, toning and resistance exercises.

Product features

Helps improve balance, coordination and flexibility.

Ideal for core strength training, stretching, toning, resistance exercises.

Safe, durable and easy to use. Includes hand pump.

Use to strengthen and tone your hips, back, legs, and shoulders without additional

stress on the spine or hips.

SKU: EYB7B255 COLOR: Grey 55cm

SKU: EYB6B065 COLOR: Purple 65cm

SKU: EYB6B175 COLOR: Blue 75cm



65
cm



75
cm



MINI GYM BALL

CONVENIENT - These exercise balls for working out are quick to inflate/deflate for easy use.

ANTI-SLIP - The surface of each fitness ball is coated in a non-slip glaze to ensure you have a proper and safe grip when working out.

RECOMMENDED BY TRAINERS AND PHYSICAL THERAPISTS - A mini ball is a perfect tool to increase balance, core fitness, tone the inner thighs, and increase flexibility.

STRENGTHEN YOUR CORE Strengthens key muscles in the abdomen, which improves endurance, posture and balance.

SKU: EVPB2W130 COLOR: Grey

25
cm
DIAMETER

FITNESS ACCESSORIES



TOP PERFORMANCE STABILITY BALL



65
cm



INCLUDES
DOUBLE ACTION INFLATING PUMP.

PRODUCT FEATURES

EXTRA THICK & ANTI BURST

This high density balance ball carry the stress of heavy loadas uo to 1100 lbs (500 KG). The stabiityball will never burst if punctured and instead excess loads above this weight will cause the ball to deflate slowly to ensure your safety.

DURABLE & ANTI-SLIP

The yoga ball made from profesional quallity pvc materials that are nontoxic, free of bpa, latex, heavy methal and phthalate. Even with sweat, the fitness ball will not slip when plying, bouncing or squeezing.

VERSATILE USE

Ideal for gyms and studio use, home excercise, yoga, pilates, pregnancy exercises, abdominal training and core strenght improving.



RATED UP TO
1100 LBS



360°
ANTI-SLIP DESIGN

HEAVY DUTY
UP TO 1100 LB/500 KG

SKU: EVYB1B006 COLOR: Black



STRENGTH,
FLEXIBILITY,
FOR AEROBICS,
YOGA OR PILATES



FITNESS BALL

STRENGTH, FLEXIBILITY, FOR AEROBICS, YOGA OR PILATES

Ideal for core workouts.

Ideal for all fitness levels.

Easy grip soft vinyl exterior.

Develop strength and flexibility.

Shape and tone.



SKU: EVFB1S05 COLOR: Pink 5lb

SKU: EVFB1S08 COLOR: Grey 8lb

FITNESS ACCESSORIES



HALF BALANCE BALL

Half ball for balance or yoga.
Non-slip to train at home or open spaces.
With side straps for basic arm and shoulder exercises
Diameter: 60 cm

SKU: EVBB2B103 COLOR: Black

60
cm
DIAMETER



INCLUDES
2
RESISTANCE
BANDS



BALANCE DISC

IMPROVES BALANCE, COORDINATION, AND OVERALL BODY SHAPE STRENGTHENS CORE MUSCLES, ANKLES, KNEES, AND HIPS.

Ideal for developing balance and stabilization.

Can be inflated or deflated to change the level of difficulty.

Great for strengthening exercises, the disc requires you to engage multiple core muscles at once to maintain balance.

Dual-textured surface ensures a non-slip grip, with raised massaging bumps on one side and smoother bumps on the other.

SKU: EVBC6B005 COLOR: Grey

33cm
13"
DIAMETER





AB WHELL

Perfect for toning abs and strengthen your arms.
 Contoured foam handles.
 Non-slip wheels that allow comfort and stability.

SKU: EVSW3W447 **COLOR:** Black



CORE WHEELS FOR DYNAMIC CORE EXERCISES

GREAT TOOL TO TONE AND DEFINE AB AND BACK MUSCLES
 Enhance traditional plank and push-up exercises.
 Wheels on each side move together for safety and ground control.
 Develop pillar strength (shoulders, torso and hips) through a variety of exercises.
 Lightweight and portable with ergonomic foam handles for comfort.

SKU: EVCW6S367 **COLOR:** Red

2 CORE WHEELS
 INCLUDES

FITNESS ACCESSORIES



AB WHEEL

GREAT TOOL TO TONE AND DEFINE AB AND BACK MUSCLES

The everlast ab wheel works both the upper and lower abdominal muscles, as well as the oblique and supporting muscles. You will also strengthen your back, glute and arm muscles.

SKU: EVSW4I47 **COLOR:** Green / Black

FEATURING
POWERCORE™
TECHNOLOGY



AB WHEEL

CORE WHEELS FOR DYNAMIC CORE EXERCISES

Enhance traditional plank and push-up exercises.
Develop pillar strength (shoulders, torso and hips) through a variety of exercises.
5 spoke inner wheel design for even weight distribution.
Ergonomic sure-grip rubberized handles.
Dual textured treads offer great traction & control.

SKU: EVWH9W400 **COLOR:** Red / Black

FEATURING
POWERCORE™
TECHNOLOGY

FITNESS ACCESSORIES



SET OF 3 HEAVY DUTY 35/45/55 LB

TRAIN DIFFERENT MUSCLES

If you go to the gym, you need to use all sorts of machines and equipment to work out specific muscle groups. With this fitness bands set, you can exercise a wide variety of muscles without the need to use heavy machines and bulky exercise gear.

Use these exercise resistance bands to build and tone your chest, lower body, upper body, abdomen, biceps, triceps, back and buttocks.

HIGH QUALITY HANDLES

The foam-coated handles of our exercise bands are anti-slip, sweat-wicking, and soft enough to prevent blisters or pain in your hands.

SKU: EVLB3W234

PERFECT WORKOUT OPTION



BEGINNER OR EXPERIENCED



INDOOR
OUTDOOR



WEIGHT
LOSS



STACKABLE UP
TO 135 LBS



GAIN
MUSCLE





FITNESS ACCESSORIES



FULL SET EXPANDER SET

5 COLOR-CODED RESISTANCE BANDS INCLUDED
PINK (5 LBS),PURPLE (10 LBS), ORANGE (15 LBS), GREEN (20 LBS), LT. BLUE (25 LBS).
Each resistance band is color-coded for instant recognizability.
It can be used alone or stacked in any combination to a maximum equivalent of 75 lbs.
Easily creating over 30 different resistance levels by attaching 1.2.3.4. Or all 5 bands to the handle.

PINK 5 LB / 2.3KG	PURPLE 10 LB / 4.5KG	ORANGE 15 LB / 6.8KG	GREEN 20 LB / 9.1KG	LT. BLUE 25 LB / 11.3KG
-----------------------------	--------------------------------	--------------------------------	-------------------------------	-----------------------------------

This complete resistance kit allows for a full body work-out without Heavy and expensive equipment.
Add or subtract bands to create the ideal weight for every exercise.
This stackable set of resistance bands can produce up to 105 lb / 48kg.
Features a metal clipping system on bands for attachment to soft-grip handles or ankle straps.

5
RESISTANCE
LEVELS

- INCLUDES:
- 5 X NATURAL LATEX TUBES
 - 2 X FOAM-HANDLES
 - 2 X ANKLE / WRIST STRAPS
 - 1 X DOOR ANCHOR
 - 1 X CARRY BAG

SKU: EVLB9W510



3 TUBE TONING SET

Fitness tubes offer one of the most convenient And versatile workouts available.
Ideal for toning and strengthening your upper body, they are a perfect complement to any cardio workout such as walking.

SKU: EVTS9W830 COLOR: Blue / Green / Orange



FITNESS TONING EXPANDER

IMPROVE YOUR BALANCE, COORDINATION, FLEXIBILITY, AND ENDURANCE
HELPS DEVELOP CORE STRENGTH.
EXERCISE SEVERAL MUSCLE GROUPS AT ONCE.
CUSHIONED FOAM HANDLES PROVIDE COMFORTABLE AND SLIP-FREE GRIP

TONER RESISTANCE LOOP

SHAPE YOUR LEGS AND IMPROVE OVERALL LOWER-BODY MUSCLE TONE .
GREAT FOR TONING HIPPS AND STRENGTHENING CALVES AND BUNS.
CUSHIONED FOAM HANDLES PROVIDE COMFORTABLE AND SLIP-FREE GRIP

FITNESS EXPANDER









STRENGTHENS ARMS, CHEST, SHOULDERS, BACK, LEGS, AND BUNS
CUSHIONED FOAM HANDLES PROVIDE COMFORTABLE AND SLIP-FREE GRIP
VERY PORTABLE-USE ANYWHERE/ANYTIME



FITNESS ACCESSORIES



INTERCHANGEABLE RESISTANCE TUBE

SKU: EVLT9W005	LATEX TUBE	5LB	Neon Pink	
SKU: EVLT9W010	LATEX TUBE	10LB	Purple	
SKU: EVLT9W015	LATEX TUBE	15LB	Orange	
SKU: EVLT9W020	LATEX TUBE	20LB	Lime	
SKU: EVLT9W025	LATEX TUBE	25LB	Light Blue	
SKU: EVLT9W035	LATEX TUBE	35LB	Red	
SKU: EVLT9W045	LATEX TUBE	45LB	Royal Blue	
SKU: EVLT9W055	LATEX TUBE	55LB	Black	



FOAM HANDLES FOR INDIVIDUAL TUBES

One size fits all.
 Wide design to accommodate all hand sizes.
 Soft foam padded and durable grip.

SKU: EVFH9W600 **COLOR:** Black



FITNESS ACCESSORIES



TRIPLE RESISTANCE TUBE

THREE DIFFERENT RESISTANCE LEVELS, TONES ABS, ARMS CHEST SHOULDERS AND BACK
 Incorporates resistance training into workout routines
 Anti-sweat, high-density foam handles
 Tone muscles, burn calories
 3 different resistance levels light, medium and heavy
 This resistance bands set is light and compact enough
 To travel with you anywhere
 Supports some of the latest workout routines

-  LIGHT RESISTANCE
-  MEDIUM RESISTANCE
-  HEAVY RESISTANCE

SKU: EVRT049 **COLOR:** Black / Yellow / Blue



RESISTANCE EXERCISE TUBE

TONES ABS, ARMS, CHEST, SHOULDERS AND BACK
 Resistant tube provides a complete workout.
 Compact and lightweight design for versatile use,
 even when traveling.
 Door strap for additional exercise options.

SKU: EVRT711-BL **COLOR:** Blue
SKU: EVRT711-PK **COLOR:** Pink



LOWER BODY POWER BANDS

ENGINEERED FOR: LATERAL RESISTANCE, LOWER BODY
 STRENGTH TRAINING, IMPROVING FOOTWORK
 Two padded hook-and-loop ankle straps provide comfort and stability during training.
 Removable gray elastic band designed to discipline footwork and athletic stance provides resistance up to 25 lbs
 Removable red elastic band, designed to strengthen knee strikes and kicks, provides resistance up to 15 lbs.

SKU: 6350RG **COLOR:** Black





**ENGINEERED FOR: LATERAL RESISTANCE,
LOWER BODY STRENGTH TRAINING,
IMPROVING FOOTWORK**

FITNESS ACCESSORIES



F.I.T. STRETCH STRAP

Developed by physical therapists, the F.I.T. Stretch Strap enhances your stretch routine to improve flexibility, recovery, and overall fitness level. Lightweight and portable, with multiple grip positions for both static and dynamic stretches. Ideal for pre- and post-workout stretching.

SKU: P00000809 COLOR: Charcoal



F.I.T. SHADOW BOXER

The F.I.T. Shadow Boxer is designed to help develop speed, power, and explosiveness for boxing, MMA, and all fight sports. Designed with foam-covered back support and handles for safety and comfort, and double-resistance tubes to help increase strength in arms and shoulders.

SKU: P00000789 COLOR: Black / Blue



F.I.T. RESISTANCE PUSH-UP

Add more intensity to your push-up with the f.i.t. resistance push-up. highly compact and portable, built with high-quality resistance tubes, hand grips, and back pad for comfort and durability.

Equipped with 3 different resistance levels for the ultimate full-body workout.

Padded handles and back support for comfort and safety. two levels of resistance for increased or decreased strength workouts.

SKU: P00000813 COLOR: Black



BANDS



- **MINI POWER BAND** offers 5lbs - 35lbs
Resistance length - 102cm width - 12mm
SKU: EVPB4R012 **COLOR:** Red
- **XSMALL POWER BAND** offers 10lbs - 50lbs
Resistance length - 102cm width - 22mm
SKU: EVPB4R022 **COLOR:** Purple
- **SMALL POWER BAND** offers 25lbs - 80lbs
Resistance length - 102cm width - 32mm
SKU: EVPB4R032 **COLOR:** Orange
- **MEDIUM POWER BAND** offers 50lbs - 120lbs
Resistance length - 102cm width - 44mm
SKU: EVPB4R044 **COLOR:** Blue
- **LARGE POWER BAND** offers 60lbs - 150lbs
Resistance length - 102cm width - 65mm
SKU: EVPB4R065 **COLOR:** Black



POWERBAND

Thick, extra strong and ideal for heavy use. Designed to work lower leg muscles, provide resistance for walks, shuffles and lunges and help to prevent and rehabilitate sprained ankles. Perfect for power assisted pull-ups/chin-ups, as well as in all fitness activities to provide added resistance to your workout.



BANDS



PILATES BANDS

Perfect for strength training, rehabilitation exercises.
Helps develop strength, coordination and balance.
Work the core abs.

SKU: EVLX4W830

3 BAND SET



PILATES RESISTANCE BANDS

Lengthen major muscles.
Target the upper and lower body.
Work the core abdominals.
Improve flexibility.
Enhance joint mobility.
Sculpt a strong, streamlined physique.

SKU: EVLX5S83

3 BAND SET



- High resistance
- Medium resistance
- Low resistance



BANS



LATEX MINIBANDS 3PACK

3-piece resistance bands give you a variety of resistance levels. Light, medium and heavy loops let you adjust the intensity of your workouts to challenge every major muscle group in your body.

3
LEVELS OF
RESISTANCE

SKU: EVMB71630 COLOR: Black / Grey / Yellow



LATEX MINIBANDS 5PACK

5-piece resistance bands give you a variety of resistance levels. **LIGHT, MEDIUM, HEAVY, X-HEAVY AND XX-HEAVY**, loops let you adjust the intensity of your workouts to challenge every major muscle group in your body.

5
MINIBANDS &
LEVELS OF
RESISTANCE

SKU: EVMB1W550

BANDS



LATEX MINI BANDS PLUS

Extra resistance and extra durability to challenge every major muscle group in your body.

ENGINEERED FOR:

RESISTANCE TRAINING, WARM UP AND REHABILITATION OF UPPER AND LOWER BODY.

SKU: EVMBOW512



HIP BAND

The durable and non-slip design hip band is made of durable cotton and latex blend.

The fabric is different from latex rubber exercise bands. These hip resistance bands will never slide or roll up when you use them. Inner grip strips inside the bands keep them in place during every exercise. INCREASE MOBILITY , MUSCLE STAMINA AND STRENGTH.

SKU: EVHPOW035 COLOR: Grey

SKU: EVHPOW038 COLOR: Burgundy

SKU: EVHPOW041 COLOR: Purple

LIGHT

MEDIUM

HARD

3
BANDS &
LEVELS OF
RESISTANCE



FITNESS ACCESSORIES



PUSH UP BARS

STRENGTHEN ABS, PECS, UPPER ARMS, AND TRICEPS.

Simple to use, strong, sturdy and durable. By using your own body weight as resistance, these push-up bars will turn ordinary push-ups into an explosive new workout routine. Uniquely designed to alleviate stress on your wrists and hands. Push ups target your chest, shoulder, and back muscles.

SKU: EVPU4I14 **COLOR:** Charcoal



NEOPRENE WEIGHTED GLOVE

Constructed from neoprene, these gloves are built to last and for optimum fit. The anatomic wrist wrap helps to secure the gloves and provide wrist stability.

SKU: EVWG6I052 **0.5KG**
X2



EST. 1944

EVERLAST

FITNESS ACCESSORIES



ARM BLASTER

PRODUCT DIMENSIONS: 23" L X 4" H, PRODUCT WEIGHT: 1KG ONE SIZE FITS ALL.
Uniquely contoured rigid metal design allows you to isolate your arms and shoulders.
Webbed nylon belt, a thick, oversized neoprene neck pad, and dense elbow pads.
The strap features a quick release to adjust it to the perfect position.
Bulk up your biceps each time you grab a workout Bar with the bicep bomber.

SKU: EVAR9H200
COLOR: Black

CURVED BODY DESIGN

The perfectly contoured shape conforms around your torso and cradles your triceps.

HEAVY DUTY CONSTRUCTION

The arm blaster body is constructed from tough gauge aluminum for a high-level workout.

SUPERIOR NECK SUPPORT

The elite neck stop is constructed from supreme foam padding for a pain-free experience.

COMFORT PADDED ENDS

The dual padded design supports your triceps and allows you to perform more reps in comfort.

INTUITIVE STRAP TECHNOLOGY

The strap features a quick release mechanism for easy adjustment into the ideal position.

ENGINEERED FOR:

TENSION
MOTION
STRENGTH

Our Arm Blaster for biceps is the ideal tool for weight lifting and body building. The blaster body supports your elbows, enabling you to keep correct posture during curls and triceps exercises.



FITNESS ACCESSORIES



DELUXE SPEED ROPE

Ball Style socket joint for smooth consistent rotation.
Adjustable 11' rope for personal customization.
Grip panels for added grip and control during use.

NEW

11'
FEET

SKU: P00002709 COLOR: Red / Black



DELUXE SPEED ROPE

ADJUSTABLE ROPE UP TO 11 FT (3.35m)
Suitable for everyone - best jump rope for any workout,
mastering double unders, exercise and fitness, mma
training, boxing, bodybuilding, personal training, home
and outdoor workouts.

11'
FEET

SKU: EVSJ6S356 COLOR: Black / Lime



ADJUSTABLE WEIGHTED JUMP ROPE

Adjustable 240 gram weight 6 40 G weights.
Weight pocket with spring loaded to keep weights in place.
Rubber grips for better control during training.
The vinyl cord is easily adjustable in length, allowing the athlete to find the optimal length for their height.

NEW

11'
FEET

SKU: P00002708 COLOR: Black / Red



FITNESS ACCESSORIES



WEIGHTED JUMP ROPE

Weighted rope.

Rubber inserts on the handle, vinyl cord that is easily adjustable in length, allowing the athlete to choose the optimal length for the best workout.

In addition to adjusting the length, the rope can be adjusted by weight, there is a cartridge weighing 130 grams in the handles, the total weight of the rope is 410 grams.

NEW

11'
FEET

SKU: P00002707 COLOR: Red / Black



EVERGRIP™ WEIGHTED JUMP ROPE

ENGINEERED FOR: SPEED, ENDURANCE, AGILITY, COORDINATION, TOTAL BODY CONDITIONING

Adjustable length, 9 ft. plastic speed rope.

Evergrip™ Handles provide added grip while training.

Removable weights to challenge your cardio and upper body training.

1.5 Lbs. Maximum Removable Weights Precision Ball Bearing Rotation For Increased Speed.

EVERGRIP™

SKU: 4485 COLOR: Black



WEIGHTED JUMP ROPE

Best aerobic exercises for burning calories, slimming down, improving flexibility, developing core strength and good heart condition.

Hold comfortably. Ergonomically designed weighted memory foam handles offer extra comfort while also preventing palm sweat and providing a firm grip.

Weights in jump rope handles are removable. Perfect for fitness workouts, cardio training, jumping exercise, cross fit, skipping, speed training, calves, thigh and forearm strengthening, leg training and endurance training.

9'
FEET

SKU: EVJROW38W COLOR: Black

FITNESS ACCESSORIES



FITNESS JUMP ROPE

ADJUSTABLE ROPE UP TO 9 FEET LONG (2.74m)
This rope is the ideal choice for a custom workout
Improve cardio endurance, develop your muscles
And tone your entire body.

9'
FEET

SKU: EVJR1Y526 **COLOR:** Black / Red
SKU: EVJR1Y526 **COLOR:** Black / Grey



ERGONOMIC JUMP ROPE

Comfortable, durable and fast
Exercise in comfort - our lightweight design and comfort
Handles reduce strain on your hands, allowing you to burn
calories and get in a great workout skipping or jumping
without unnecessary discomfort

SKU: EV3JTP01 **COLOR:** Yellow
SKU: EV3JTP01 **COLOR:** Black
SKU: EV3JTP01 **COLOR:** Pink



LEATHER JUMP ROPE

High durability and speed
High quality precision ball bearings
Comfortable and smooth handling

9'
FEET

SKU: EVLR8800 **COLOR:** Leather



FITNESS ACCESSORIES



JUMP ROPE

Ajustable, durable and fast

ENGINEERED FOR: Speed, endurance, agility, coordination, and total body conditioning. Improve cardio endurance, develop your muscles and tone your entire body

SKU: EVJR7Y15-1 COLOR: Transparent

SKU: EVJR7Y15-2 COLOR: Blue

SKU: EVJR7Y15-3 COLOR: Orange

SKU: EVJR7Y15-4 COLOR: Fucsia

SKU: EVJR7Y15-5 COLOR: Green



JUMP ROPE

Improve your balance, coordination, flexibility, and endurance

Helps develop core strength.

Exercise several muscle groups at once.

9'
FEET

SKU: EVXR800-BK COLOR: Black

SKU: EVXR800-BL COLOR: Blue

SKU: EVXR800-PK COLOR: Pink

ENGINEERED FOR:
SPEED, ENDURANCE, AGILITY, COORDINATION,
AND TOTAL BODY CONDITIONING.



JUMP ROPE

High durability and speed.

High quality precision ball bearings.

Comfortable, durable and fast.

Exercise in comfort - our lightweight design and comfort foam.

Handles reduce strain on your hands, allowing you to burn calories and get in a great workout.

skipping or jumping without unnecessary discomfort.

SKU: EVJR1Y666 COLOR: Red / Green / Yellow / Blue

9'
FEET



MULTIPLE WAYS TO TRAIN



PUSHUPS

DIPS

INVERTED ROWS

ADJUSTABLE POWER BRACKETS

PERFECT FOR BEGINNERS & ADVANCED
Improve strength and cardio, for all skill levels, secure grip.

Material ensures a secure grip during use.
Perfect fitness tool used to improve strength and cardio fitness.
Easily adjustable iron bracket can be modified according to exercise and skill level from 22" to 30"
Specially designed to be used as hurdles or for dips, pushups, inverted rows and more.

SKU: EVPB5S65 COLOR: Black / Lime

EVERGRIP



FITNESS ACCESSORIES



HOME TRAINING BAR

PERFECT FOR BEGINNERS & ADVANCED

Three grip positions, narrow, wide, and neutral Turns any doorway into a personal gym, Installs in seconds ideal for pull-ups, push-ups, chin-ups, dips, crunches, and more Uses leverage to hold against the doorway so there are no screws and no damage to door.

SKU: EVDB059 COLOR: Black



ADJUSTABLE PULL UP BAR FOR DIFFERENT DOORWAYS

63 cm / 25 in

EXTEND TO

100 cm / 39 in

Adjustable length 63/100cm
Tube diameter: 28mm

DELUXE DOORWAY BAR

EASY TO INSTALL

You only need a screwdriver.

Install in minutes. The safety end caps keep your door from being damaged or marked up and keeps you safe. Please check doorway bar before each use to make sure it is tightly installed.

EASY TO TAKE DOWN WHEN NOT IN USE.

EASY TO MOVE FROM TOP OF DOORWAY TO BOTTOM.

PLACE IT AT PROPER HEIGHT FOR YOUR NEEDS.

SUITABLE FOR ANY STANDARD DOOR FRAME

SKU: EVDB3W150 COLOR: Black



ANTI-SKID PAD
Increase the friction to prevent movement wobble.



EVA FOAM GRIP
Anti-skid, absorbent and comfortable.



ANTI-SKID RING
Reduce the friction between two pieces of tubes.



REINFORCED ACCESSORY
Used for safety and steadiness sake.



Maximum load: 150kg

150 KG
MAXIMUM CAPACITY

ENGINEERED FOR:

MULTIPLE EXERCISES AT HOME - OUR HOME PULL UP BAR CAN BE USED FOR PULL UPS, CHIN UP, KNEE RAISES, L-SITS, BACK STRETCHES.

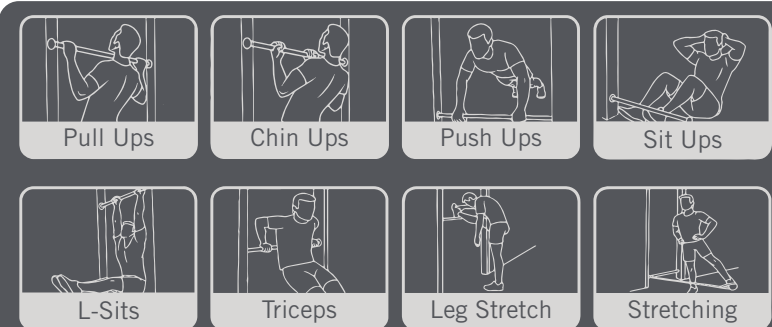

FITNESS ACCESSORIES



WALL MOUNTED DIP

(56.5cm x 64cm x 30cm)

Expand your weight room by using the everlast all mounted dip station. Increase the strength of your chest, shoulders And triceps. Once your workout is complete, Return the mount to its space saving position.

SKU: EVWD5R120 COLOR: Black

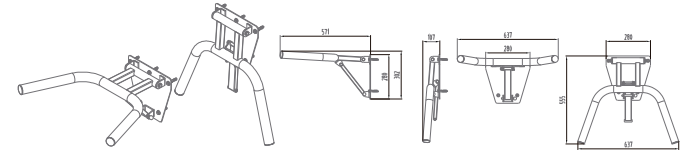

CHIN UP BAR

Easy assembly & installation
Holds up to 140kgs
Made from high quality steel
Mounts on to any solid wall
Offers a variety of grip positions & exercises

SKU: EVCH4R207 COLOR: Black

HOLDS UP TO
140
kgs
Structure 131cm X 58cm X 60cm

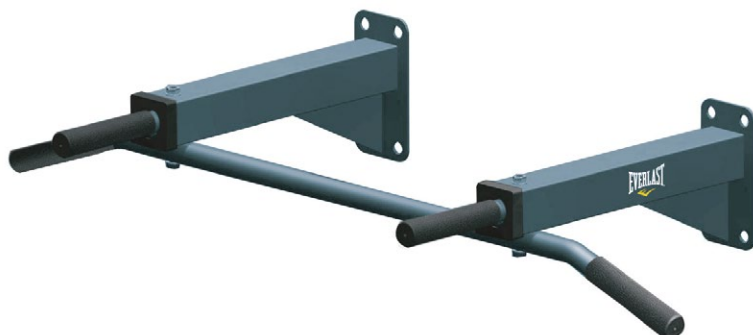

CHIN UP BAR

Easy assembly & installation
Made from high quality steel
Mounts on to any solid wall
Offers a variety of grip positions & exercises
ENGINEERED FOR:
TOTAL BODY CONDITIONING
STRENGTH TRAINING
INTENSE CARDIOVASCULAR WORKOUTS

SKU: EVCH9W450 COLOR: Grey / Black

HOLDS UP TO
140
kgs
Structure 100cm x 18cm



AB SLING

THE AB SLING HANGING STRAPS ARE ATTACHMENTS FOR PULL-UP BARS THAT TARGET ABDOMINAL AND LOWER BACK MUSCLES. THESE 2 AB STRAPS HAVE AN LOOP SUPPORT THAT DISPERSES ANY PRESSURE FROM YOUR ARMS WHILE YOU HANG IN PLACE.

CORE MUSCLE TRAINING: The Ab Sling is the perfect hanging-strap equipment to use to strengthen and tone your core. Rest your arms into the arm slings and perform knee tucks, crunches, full L-sits, or any other core exercises.

Extra foam cushioning for added comfort.

For all fitness levels.

SKU: EVAS3R150 **COLOR:** Black



WEIGHTED DIP BELT HELPS BUILD POWER AND STRENGTH IN TRICEPS AND CHEST

ENGINEERED FOR:
INCREASE STRENGTH AND MUSCLE GAINS

FITNESS ACCESSORIES



DIP BELT

Dip belt constructed of durable polypropylene with heavy duty steel grommets to secure chain to belt. Contoured belt design provides back support and fits comfortably during training. Steel chain and carabiner mechanism to easily add weight. Weighted dip belt helps build power and strength in triceps and chest. Adjustable, one size fits all.

SKU: EVDP2W200 COLOR: Black

EVERLAST

MAX OUT YOUR UPPER BODY
Increase the additional weight around your waist to get stronger, tone and build muscle faster.



FITNESS ACCESSORIES



SUSPENSION SYSTEM DELUXE

LETS YOU USE YOUR BODYWEIGHT WITH THE NATURAL FORCE OF GRAVITY.

Total-body workout system you can set up in less than 60 seconds at home or anywhere you go. Get stronger, build muscle, lose weight and improve flexibility fast no weights required.

Work out total body, burn fat and tone all lean muscles this trainer is a complete bodyweight gym that supports highly metabolic compound exercises and assisted exercise variations for full workouts for every skill level.

Increase muscle endurance & sport performance infinitely variable resistance. Full body resistance trainers feature indexed straps and quick adjust buckles so you can tailor resistance for each exercise.

SKU: EVST9W008 COLOR: Black / Red



ANTI-SLIP
FOAM RUBBER HANDLE



HEAVY DUTY
ZINC-ALLOY CARABINER



ADJUSTABLE
EASY TO SET BUCKLE



SUPER STURDY
DOOR ANCHOR

PACKAGE INCLUDED:
TWO BODYWEIGHT RESISTANCE STRAPS
ONE EXTENSION STRAP
ONE CARRY POUCH
ONE USER MANUAL
ONE DOOR ANCHOR

FITNESS ACCESSORIES



NEW

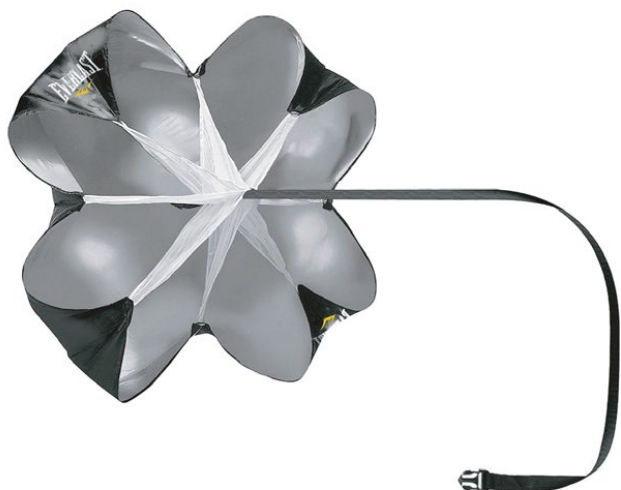

POWER CHUTE

IMPROVES SPEED AND ACCELERATION:

This running parachute is designed to produce 15-30 pounds of resistance during sprinting to simultaneously perform speed and strength training.

It effectively promotes explosiveness and stamina that is vital in field and track sports.

SKU: EVPC9W292 COLOR: Black



55"
DIAMETER

APPROXIMATELY 15-30 LBS. OF RESISTANCE

PACKING CONTENT

ONE 55 INCHES UMBRELLA
ONE WAIST BELT RESISTANCE PARACHUTE
ONE CARRYING BAG

ADJUSTABLE BELT: 2-inch heavy-duty belt is fully adjustable and will comfortably fit almost any athlete.

The 360-degree rotation belt allows you to train in any direction.

When positioned on the right or left hip, it allows you to get off the line laterally.



RECOIL 360°

Develops proper acceleration mechanics while challenging your postural strength and stability during partner harness runs.

360° rotation belt with free motion ring allows for movement in any direction.

Trains all sport movements while switching between resistance and assistance.

Designed for solo use or for training with a partner.

CABLE STRETCHES

from 8 to 22 feet with resistance that increases from 15 to 50 lb.

Unique flexi-cord design stretches against your movement to build strength or pulls you along to increase speed and improve your body's efficiency during direction changes.

SKU: EVRC1W360 COLOR: Black

360°
DEGREES OF MOVEMENT

FITNESS ACCESSORIES

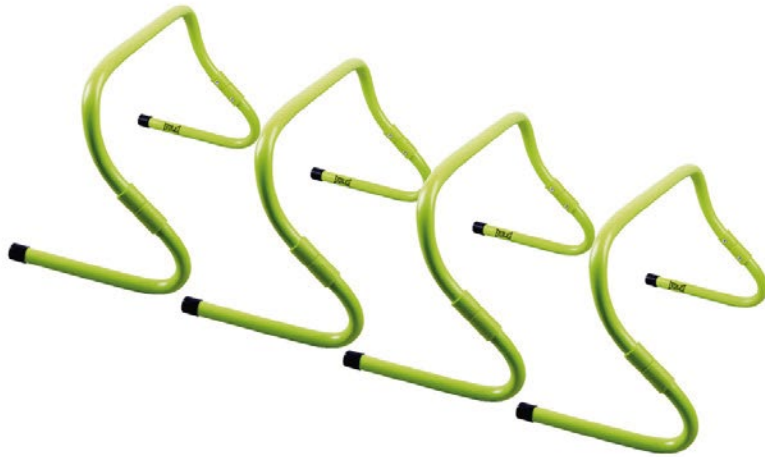

ADJUSTABLE HURDLES

ADJUSTABLE-HEIGHT OPTIONS OF 8" AND 12"
FOR MULTIPLE TRAINING CONFIGURATIONS
INDOORS OR OUTDOORS

Adjustable height for a varied challenge.
No assembly necessary.
Offers multiple workout configurations.
Suitable for speed and accuracy training.
Lightweight design for easy storage.

INCLUDES
4
HURDLES

SKU: EVAH9W040 COLOR: Green



AGILITY LADDER

16 FEET IN LENGTH WITH 10 ADJUSTABLE FLAT RUNGS

Find the perfect rhythm in your training with this performance focused product. Improve your acceleration, lateral speed and change of direction while enhancing balance, Rhythm and body control. These core skills are critical to any athlete that wants to perform At a faster level than the competition in any sport.

Develop explosive power, speed and better footwork.
This flat rung ladder improves technique and responsiveness.
The quick ladder caters to all sports as it increases efficiency for all athletes.

SKU: EVAL9W510 COLOR: Green / Black

5m
16 FEET
FLAT-RUNG AGILITY LADDER



CARRY STORAGE BAG
INCLUDED



EVERLAST

EVERLAST

EVERLAST

FITNESS ACCESSORIES



AB MAT TRAINER

EVERLAST AB MAT TRAINER PROVIDES:

Offers low-back comfort and support during ab exercises.

The contoured shape promotes safe lumbar extension, placing the abdominal muscles on a pre-stretch position resulting in a maximal abdominal activation. It is the perfect complement to a mat routine, elevating the body off the floor during crunches, curls, Sit-ups, side bends and back extensions.

SKU: EVAB9W100 **COLOR:** Black



AB MAT PRO ABDOMINAL TRAINER

THE EVERLAST AB MAT PROVIDES:

The full range of motion necessary to work the entire Abdominal muscle group.

A variety of exercises that isolate upper and/or lower abs, as well as the obliques and lower back muscles.

A safe, comfortable design contoured to your lower back Which helps to prevent injury and supports your spine.

SKU: EVAB4S06

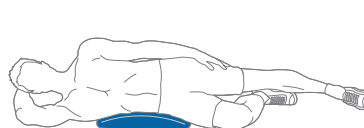

SIDE CRUNCH



EVERLAST
4KG

KETTLEBELLS



PLASTIC KETTLEBELL

SKU: EVKB3W100 COLOR: Black 10lb



SOFT BASE KETTLE BELLS

Soft base reduce noise, protect the floor.

Soft and comfortable grip.

Kettlebells is a great option for getting a full-body workout in a short time.

HELP DEVELOP FUNCTIONAL STRENGTH, ENDURANCE, CORE STABILITY AND BALANCE

Tone and strengthen major muscles, develop core, burn body fat and build power.

Easy grip ergonomic handle with durable PVC outer casing.

SKU: EVSK1B712 COLOR: Grey 12kg

SKU: EVSK1B708 COLOR: Yellow 8kg

SKU: EVSK1B704 COLOR: Pink 4kg



ENGINEERED FOR:

SPEED, ENDURANCE, AGILITY, COORDINATION,
AND TOTAL BODY CONDITIONING.

AVAILABLE WEIGHTS PESOS DISPONIBLES

4KG / 8KG / 12KG



KETTLEBELLS



PVC KETTLEBELLS

Works All Muscles Simultaneously And Increases Heart Rate While Strengthening And Sculpting The Entire Body.

- SKU: EVKB2S05 COLOR: Black (5Lb)
- SKU: EVKB2S08 COLOR: Burgundy (8Lb)
- SKU: EVKB2S10 COLOR: Navy (10Lb)

VINYL DIPPED KETTLEBELLS

Total Body Cardio Workout, Burn Fat And Effective Toning works great for your stabilizing muscles for active recovery build your strength, stability and power improve movement, agility and speed

- SKU: EVVK9W004 COLOR: Orange 4kg
- SKU: EVVK9W006 COLOR: Red 6kg
- SKU: EVVK9W008 COLOR: Blue 8kg
- SKU: EVVK9W010 COLOR: Lime 10kg
- SKU: EVVK9W012 COLOR: Grey 12kg



8KG



4KG

6KG

10KG

12KG

KETTLEBELLS



SOFT KETTLEBELL

Heavy Duty Stitching For Extra Strength And Durability.
High Density Stuffing To Keep Weight Centered During Use.
Flat Bottom.
Handles Are Easy To Grip And Will Hold Chalk.
Soft Material And Stuffing Provides Safety During
Workouts And Protects Flooring.

SKU: EVSK7R06 6Kg COLOR: Black / Yellow

SKU: EVSK7R10 10Kg COLOR: Black / Blue

SKU: EVSK7R14 14Kg COLOR: Black / Red

SKU: EVSK7R16 16Kg COLOR: Black / Orange



H.I.T. HIGH INTENSITY TRAINING



KETTLEBELL DLX

A training plan with kettlebell is suitable for all who want to vary your training fitness and force. Everlast kettlebells are available in the weight increments you need from lightweight Beginner bells starting at 4kg / 9lb to 32kg / 70lb. Color-coded handles for easy recognition. Texture matters. A well formed, balanced, and properly textured kettlebell feels better in the hand and performs better in motion.

- SKU: EVIK8R009 COLOR: White 4kg / 9lb
- SKU: EVIK8R018 COLOR: Pink 8kg / 18lb
- SKU: EVIK8R026 COLOR: Blue 12kg / 26lb
- SKU: EVIK8R035 COLOR: Yellow 16kg / 35lb
- SKU: EVIK8R044 COLOR: Grey 20kg / 44lb
- SKU: EVIK8R053 COLOR: Green 24kg / 53lb
- SKU: EVIK8R070 COLOR: Red 32kg / 70lb



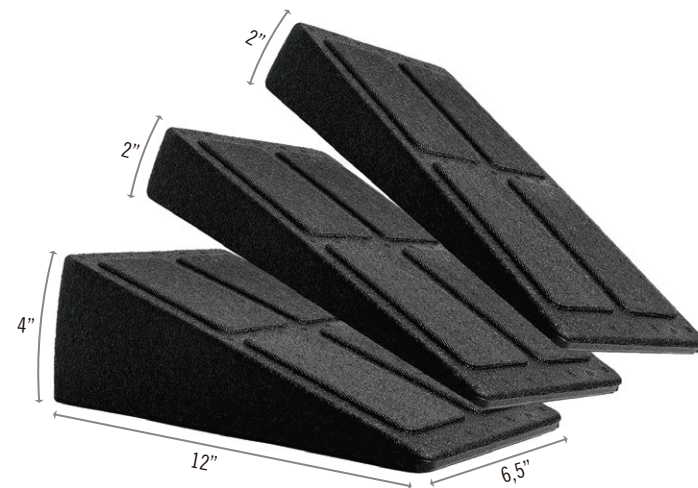

SQUAT WEDGE BLOCKS

GET MORE OUT OF YOUR SQUATS

Athletes in all types of sports and disciplines have recognized the benefits of squat wedges as a means for increasing squat depth and range of motion, engaging the quads, protecting and strengthening the knees.

3
BLOCKS

SKU: EVSW4W324

A close-up photograph of a person's hands holding a blue and black medicine ball. The ball is spherical with a textured black fabric cover and blue panels. The word "EVERLAST" is printed in white, bold, sans-serif capital letters on the upper blue panel, with a white stylized "E" logo underneath. The weight "20lbs" is printed in white, bold, sans-serif capital letters on the lower blue panel. A black strap with a diamond-patterned stitching is visible across the middle of the ball. The person's hands are positioned on the left and right sides of the ball, and their forearms are visible. The background is a blurred outdoor setting with a concrete floor.

EVERLAST

20lbs

MEDICINE BALL



BODY TRAINING TOOL THAT HELPS DEVELOP MUSCULAR STRENGTH, ENDURANCE, POWER, STABILITY AND JOINT INTEGRITY

Improve your overall body muscle mass, cardiovascular endurance, and hand-eye coordination. Run longer, jump farther, lift more and perform better. Textured surface allows for a high quality grip even when wet.

SKU: EVRM2W14 **4 kg** **COLOR:** Black / Red

SKU: EVRM2W15 **5 kg** **COLOR:** Black / Blue

SKU: EVRM2W16 **6 kg** **COLOR:** Black / Grey



STRENGTH TRAINING, TOTAL BODY CONDITIONING, ENDURANCE, AGILITY, COORDINATION, CARDIO CONDITIONING.



MEDICINE BALL



BODY TRAINING TOOL THAT HELPS DEVELOP MUSCULAR STRENGTH, ENDURANCE, POWER, STABILITY AND JOINT INTEGRITY

Improve your overall body muscle mass, cardiovascular endurance, and hand-eye coordination. Run longer, jump farther, lift more and perform better. Textured surface allows for a high quality grip even when wet.

SKU: EVRMOW02 **2 kg** COLOR: Black / Purple

SKU: EVRMOW03 **3 kg** COLOR: Black / Green

SKU: EVRMOW04 **4 kg** COLOR: Black / Orange

SKU: EVRMOW05 **5 kg** COLOR: Black / Blue

SKU: EVRMOW06 **6 kg** COLOR: Black / Red



STRENGTH TRAINING, TOTAL BODY CONDITIONING, ENDURANCE, AGILITY, COORDINATION, CARDIO CONDITIONING.

SLAM BALL



10LB



20LB

LOW BOUNCE

Due to the heavy weight composition of these Slam Balls, they will supply a low and even bounce with and provide complete control to users.

STRENGTH DEVELOPMENT

Everlast Slam Ball has been designed to improve a variety of muscle groups, making it ideal for functional training that can assist in response time, endurance and speed.

SLAM BALL

Slam Balls will help you unleash your power! Engage your entire body in a high-intensity EVERLAST Slam Ball workout that builds strength, cardio and explosive power.

Rugged, textured surface that provides easy gripping and helps you keep a sure handle on the ball.

SKU: EVSM2W010 10LB COLOR: Black

SKU: EVSM2W020 20LB COLOR: Black

SPECIAL TREAD DESIGN

Easy to grip surface: features rugged, textured surface with ergonomic triangular patterns for a better grip, increasing both efficiency and safety when exercising.

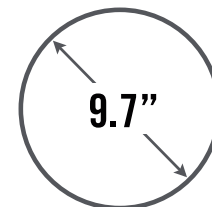

MEDICINE BALL



POWERCORE BAG MEDICINE BALL

Medicine ball is a great tool for a complete body workout and ideal for building muscle. It can be used for a range of applications such as gymnastics, general fitness, increasing stamina and therapeutic applications in physical rehabilitation programs.

SKU: EV3085 5kg **COLOR:** Black

SKU: EV3086 4kg **COLOR:** Black

SKU: EV3087 3kg **COLOR:** Black

SKU: EV3088 2kg **COLOR:** Black

SKU: EV3089 1kg **COLOR:** Black



WALL BALL



WALL BALL (10lb 14lb 20lb 30lb)

CARBON FIBER FABRIC

Balls are ideal for rotational movements, core exercises of many types and dynamic strength training all while the ball remains dimensionally stable and balanced and moisture and scuff resistant.

Soft shell, heavy duty vinyl coated nylon construction design holds its shape over time and allows you to strike balls with arms and legs for more diverse training.

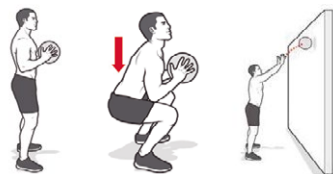

SKU: EVWL7R010 10lbs COLOR: Black / Orange

SKU: EVWL7R014 14lbs COLOR: Black / Green

SKU: EVWL7R020 20lbs COLOR: Black / Blue

SKU: EVWL7R030 30lbs COLOR: Black







POWERCORE BAGS

The power bag from everlast is a versatile training tool to develop strength and cardiovascular fitness.

THE BAGS CAN ALSO BE USED IN A VARIETY OF WAYS;

Squats, walking lunges, chest press, shoulder press or explosive throw drills. alternatively lighter bags can be used with a training partner to throw, catch and move.

SKU: EVSB7S710 **10kg** **COLOR:** Red

SKU: EVSB7S715 **15kg** **COLOR:** Blue

SKU: EVSB7S720 **20kg** **COLOR:** Grey





PLATES

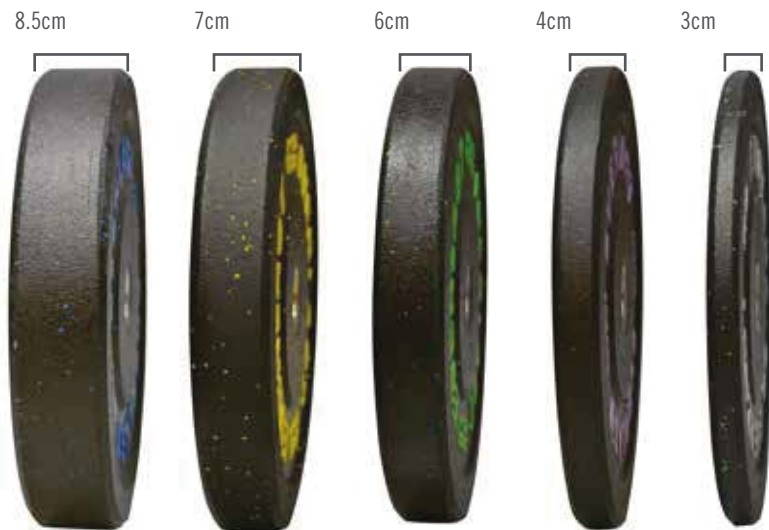

HI-IMPACT BUMPER PLATES

DIAMETER: 45cms

Heavy-duty bumper plates designed to resist the heaviest of workouts.
Made of recycled crumb rubber.
Drop test: 2m x 8000 repetitions.
Steel rim bushing.

- SKU: EVBP8R010 10LB COLOR: Grey
- SKU: EVBP8R015 15LB COLOR: Pink
- SKU: EVBP8R025 25LB COLOR: Green
- SKU: EVBP8R035 35LB COLOR: Yellow
- SKU: EVBP8R045 45LB COLOR: Blue



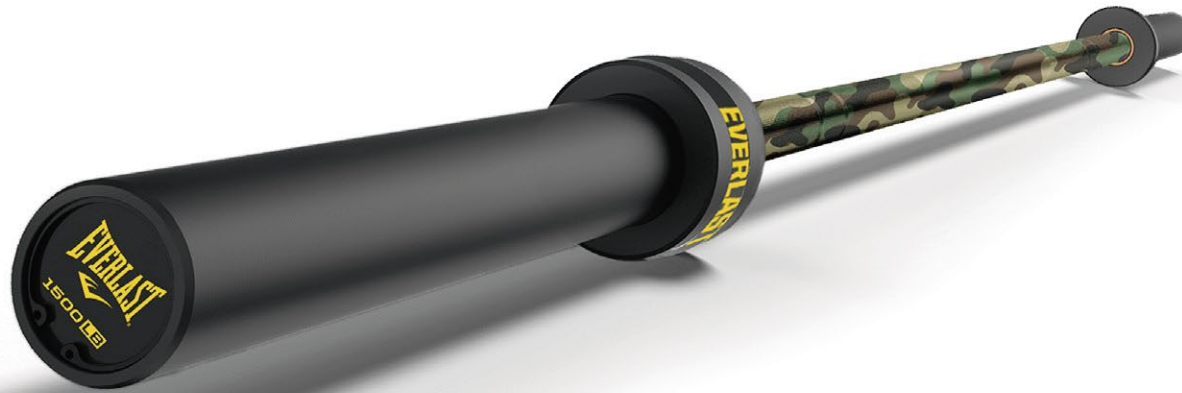

**Men's Bars
1500 LB**



**Women's Bars
1000 LB**



28mm CROSS FIT BARS, 7'

25mm CROSS FIT BARS, 6'

Brass bushings for reliable spin and satisfactory whip
 Knurling marks for both olympic and power lifting Bar collars are snap ring design
 Bearings allow the hard chrome sleeves to rotate freely promoting a smoother, quieter spin.
 Material :Alloy Steel with heat treatment

SKU: EVOB0R186 (1500 LB) WEIGHTLIFTING BAR, 7'
 SKU: EVOB0R115 (1000 LB) WEIGHTLIFTING BAR, 6'



LOCKS NOT INCLUDED
 SKU: EVOCR100

TRAINING RACK



STRENGTH TRAINING RACK

MULTIDIRECTIONAL WORKOUTS:

Use the Synergiee Landmine Platform with your barbell to introduce new modalities for lifting, lunges, squats, rows, presses, and rotational exercises. This lever is an incredible tool for building functional strength by mimicking 360-degree movement patterns we execute in our everyday lives that require strength, power, and coordination! PLUS, this platform includes a spot to anchor your Battle Rope!

SKU: EVTR1W250
COLOR: Black / Yellow

ENGINEERED FOR:

STRENGTH TRAINING
TOTAL BODY CONDITIONING
SPORT SPECIFIC TRAINING
CARDIO CONDITIONING

360 DEGREE

PIVOTING DESIGN, IDEAL FOR
A BROAD RANGE OF EXERCISES



WOOD GYM RINGS

Perfect for multiple exercises such as: Push-ups, iron cross, dips, muscle ups, pull-ups and many more.

Each set contains two rings and two numbered straps.

Superior feel of natural wood for a secure grip, even without chalk

Sold in sets of 2

Diameter: 1.25" standard

Firm grip with or without chalk

Includes (2) 1.5" Heavy Duty Black Nylon Straps with Buckle*

18' Strap long straps, 25mm wide strap

SKU: EVGROW125



ROPES



POWER ROPE

ENGINEERED FOR: TOTAL BODY CONDITIONING, STRENGTH, CARDIOVASCULAR TRAINING, IMPROVED GRIP STRENGTH

30' Rope, 1.5" Diameter.

Durable synthetic blend with contoured handles.

ENGINEERED FOR:

Total body conditioning

Strength training

Intense cardiovascular workouts

SKU: EVBR9W623 COLOR: BLACK

SIZE: BATTLE ROPE 9 m x 38 mm diámetro

CLIMBING/UTILITY ROPE WITH ANCHOR

Climbing ropes have always been one of the most popular and standard equipment requests for overall improvement of physical fitness and muscle tone, particularly for upper arms and shoulders.

Extremely popular training apparatus for strength, grip and arm coordination skills for use in physical education, wrestling, gymnastics, military, and cross-fit applications. Landing mats, spotting and supervision suggested when using.

SKU: EVCR4R380

SIZE: 38mm /length: 15m

SKU: EVCR4R500

SIZE: 50mm /length: 15m



PLYOMETRIC WOODEN BOX

Our 3-in-1 power box is a staple item of any fitness studio or crossfit box. Simply rotate the wooden box to your desired height and jump.

This item is cnc machine cut with rounded edges and pre drilled screws makes this box a very fast to install.

Plyometric exercises are perfect to improve an athletes ability and skill and will seriously increase speed and strength.

SKU: EVBX8R243

SIZE: 20" x 24" x 30"

PLYOMETRIC BOX



SOFT PLYOMETRIC BOX

The soft shell cushions the impact and protects the shins and knees on those missed jumps. plyometric training will develop your explosivity and power while increasing balance and agility

SKU: P00001772

SIZE: 20" x 24" x 30"

AEROBIC STEPPER



AEROBIC STEPPER

Internal storage compartment.

Incline / decline / flat

Non slip textured rubber surface

Dimensions: 121.5 x 34.5 x 35.5cm

has 3 position angle support.

Flat

Choice of two heights: With two heights to choose from (8in or 14in), you can step, jump and lunge your way to improved aerobic fitness - or perform traditional flat workout bench strength exercises.

Incline

Create an incline workout bench: With a simple adjustment of the Deck's secure 'lid', you have yourself an incline workout bench which is an ideal position for those exercises which build the upper chest, such as flys and presses.

Decline

Clip in feet to decline the Deck: Easily fold and lock one of the Deck's feet into place to focus on decline exercises such as crunches or standing rows with a resistance band placed inside one of the clips.

SKU: EVSP1W805

COLOR: Red / Black

2 HEIGHT POSITIONS

ADJUSTABLE COMPACT AND STACKABLE DESIGN.
NON-SLIP SWEAT-RESISTANT WORKOUT SURFACE.
SIMPLE CLICK AND LOCK FEET ADJUSTMENT.
IDEAL FOR EFFECTIVE CARDIO EXERCISES.
SAFE AND SECURE NON-SLIP.



EVERLAST
E

**WEIGHT LIFTING
GLOVES**

WEIGHT LIFTING & EXERCISE GLOVES



PULSE

Comfortable Fit Anatomic Shape
 Breathable And Flexible.
 Maximum Protection And Durability.
 Adjustable Velcro Closure
 wrist puller for easy removal

SKU: EVWG3H441 **COLOR:** Black / Black **XS - S - M**
SKU: EVWG3H444 **COLOR:** Black / Lemon
SKU: EVWG3H445 **COLOR:** Black / Red



AUTHORITY III

Confortable fit anatomic shapeVelcro closure maximum grip and durability
 Brethable and flexible Adjustable velcro closure.
 Maximum protection and durability Anatomic shape, comfortable fit.

SKU: EVWG7K8A51 **COLOR:** Black
SKU: EVWG7K8A52 **COLOR:** Black / Grey

S - M - L - XL



WEIGHT LIFTING & EXERCISE GLOVES



ECLIPSE

Pull off tabs for easy removal.
Breathable and flexible.
Comfortable fit.
Adjustable velcro closure added protection.

SKU: EVWG9H061 **COLOR:** Black
SKU: EVWG9H062 **COLOR:** Black / Gray

S - M - L - XL

FEATURING
EVERCOOL™
TECHNOLOGY



POWER HOUSE II

Pull Off Tabs For Easy Removal Comfortable Fit Anatomic Shape
Velcro Closure Maximum Grip And Durability Breathable And Flexible.
Adjustable Wrist Wrap Provides Support And Flexibility Maximum
Protection And Durability.

SKU: EVWG7K9P01 **COLOR:** Black
SKU: EVWG7K9P02 **COLOR:** Grey / Black

S - M - L - XL

ENGINEERED FOR: WEIGHT LIFTING FEATURING
EVERCOOL™
TECHNOLOGY



WEIGHT LIFTING & EXERCISE GLOVES



ARROW

Pull off tabs for easy removal Comfortable fit anatomic shape
Velcro closure maximum grip and durability Brethable and flexible.
Adjustable wrist wrap provides support and flexibility Maximum
protection and durability.

SKU: EVWG7H642
COLOR: Black / Grey

ENGINEERED FOR
WEIGHT LIFTING

S - M - L - XL
FEATURING
EVERCOOL™
TECHNOLOGY



XCORE

Pull off tabs for easy removal Brethable and flexible.
Anatomically shaped and added flexibility Extra gel protection and durability.
Adjustable wrist wrap provides strong support

SKU: EVWG9H501
COLOR: Black

S - M - L - XL



WEIGHT LIFTING & EXERCISE GLOVES



BULLET

Pull off tabs for easy removal.
Breathable and flexible. anatomic shape.
Comfortable fit.
Adjustable wrist wrap provides strong support.
Maximum grip and added protection.

SKU: EVWG9H911 COLOR: Black

S - M - L - XL



TOTAL STRENGTH III

Pull Off Tabs For Easy Removal Anatomic Shape.
Comfortable Fit. Breathable And Flexible.
Adjustable Velcro Closure. Maximum Protection And Durability.

SKU: EVWG7K7T01 COLOR: Black
SKU: EVWG7K7T02 COLOR: Grey / Black

ENGINEERED FOR:
WEIGHT LIFTING

S - M - L - XL

FEATURING
EVERCOOL™
TECHNOLOGY



WEIGHT LIFTING & EXERCISE GLOVES



PEARL FORCE

Pull off tabs for easy removal.
 Breathable and flexible.
 Anatomically shaped and added flexibility.
 Extra gel protection and durability.
 Adjustable wrist wrap provides strong support.

SKU: EVWG9H300
COLOR: Black

S - M - L
 FEATURING
EVERCOOL™
 TECHNOLOGY



FLEX PRO

Pull off tabs for easy removal.
 Breathable and flexible.
 Anatomically shaped.
 Comfortable fit.
 Maximum grip and protection.
 Adjustable wrist wrap provides strong support and flexibility.

SKU: EVWG9H871
COLOR: Black / White

S - M - L
 FEATURING
EVERCOOL™
 TECHNOLOGY



SNAP

Pull off tabs for easy removal.
 Breathable and flexible.
 Anatomically shaped.
 Comfortable fit.
 Maximum grip and protection.
 Stretch and snug fit to your hands.

SKU: EVWG9H215
COLOR: Black / Pink

M - L
 FEATURING
EVERCOOL™
 TECHNOLOGY



WEIGHT LIFTING & EXERCISE GLOVES



BREEZE

Anatomically shaped.
Breathable and flexible.
Comfortable fit.
Maximum grip and protection.
Adjustable wrist wraps provides support and flexibility.

- SKU: EVWG9H641 **COLOR:** Black / Pink
- SKU: EVWG9H642 **COLOR:** Gray / Black
- SKU: EVWG9H643 **COLOR:** Black / Pink

S - M - L
FEATURING
EVERCOOL™
TECHNOLOGY



VENTO

Pull off tabs for easy removal.
Anatomically shaped.
Breathable and flexible.
Comfortable fit.
Silicone print in palms for maximum grip.
Adjustable wrist wrap provides support and flexibility.

- SKU: EVWG9H751 **COLOR:** Black / Gray
- SKU: EVWG9H752 **COLOR:** Black / Pink

S - M - L
FEATURING
EVERCOOL™
TECHNOLOGY



SUPER FIT

Pull off tabs for easy removal
Comfortable fit
Anatomically shaped
Mesh ventilation panels.
Silicone print in palms for maximum grip.
Adjustable wrist wrap provides support and flexibility

- SKU: EVWG7H801 **COLOR:** Black / Lime
- SKU: EVWG7H802 **COLOR:** Black / Aqua
- SKU: EVWG7H803 **COLOR:** Black / Fuchsia

S - M - L
FEATURING
EVERCOOL™
TECHNOLOGY



WEIGHT LIFTING & EXERCISE GLOVES



VELVET

Comfortable Fit Anatomic Shape
Breathable And Flexible.
Maximum Protection And Durability.
Adjustable Velcro Closure
wrist puller for easy removal

SKU: EWG6S401 **COLOR:** Black **XS - S - M**
SKU: EWG6S402 **COLOR:** Black / Pink



HEATHER

Pull off tabs for easy removal
Comfortable fit
Anatomically shaped
Mesh ventilation panels.
Silicone print in palms for maximum grip.
Adjustable wrist wrap provides support and flexibility

SKU: EVWG7F011 **COLOR:** Black
SKU: EVWG7F001 **COLOR:** Neon Orange
SKU: EVWG7F002 **COLOR:** Neon Yellow
SKU: EVWG7F003 **COLOR:** Neon Pink
SKU: EVWG4F005 **COLOR:** Purple
SKU: EVWG7F002 **COLOR:** Lila
SKU: EVWG7F006 **COLOR:** Pink

ENGINEERED FOR:
WEIGHT LIFTING
LIGHT EXERCISE
CYCLING
S - M
FEATURING
EVERCOOL™
TECHNOLOGY

WEIGHT LIFTING & EXERCISE GLOVES



ALPINO II

Comfortable fit
 Anatomic shape
 Breathable and flexible
 Maximum protection and durability
 Anatomic shape

SKU: EVWG6KA02 **COLOR:** Black / Blue
SKU: EVWG6KA03 **COLOR:** Black / Red
SKU: EVWG6KA04 **COLOR:** Black / Neon Yellow
SKU: EVWG6KA05 **COLOR:** Black / Neon Pink

S - M - L - XL



ALPINO

Comfortable fit
 Anatomic shape
 Breathable and flexible
 Maximum protection and durability
 Adjustable velcro closure

SKU: EVWG9A02 **COLOR:** Gray / Black / Yellow

S - M - L

CYCLING GLOVES



GALAXY

ELASTIC TOP HAND MATERIAL FOR PERFECT FIT
PALM PADDING DESIGNED TO PROTECT YOUR
HANDS AND ENHANCE FLEXIBILITY
REINFORCEMENTS AT HIGH ABRASION ZONES
FOR MAXIMUM PROTECTION AND DURABILITY
PULL OFF TABS FOR EASY REMOVAL
ADJUSTABLE CLOSURE PROVIDES A SECURE FIT

SKU: EVWG3H303 **COLOR:** Blue / Black

S - M - L - XL

SKU: EVWG3H304 **COLOR:** Lemon / Black

SKU: EVWG3H305 **COLOR:** Red / Black

SKU: EVWG3H306 **COLOR:** Pink / Black



GIRO

ELASTIC TOP HAND MATERIAL FOR PERFECT FIT
PALM PADDING DESIGNED TO PROTECT YOUR
HANDS AND ENHANCE FLEXIBILITY
REINFORCEMENTS AT HIGH ABRASION ZONES
FOR MAXIMUM PROTECTION AND DURABILITY
PULL OFF TABS FOR EASY REMOVAL
ADJUSTABLE CLOSURE PROVIDES A SECURE FIT

SKU: EVCG6H111 **COLOR:** Black / Lime

S - M - L - XL

SKU: EVCG6H112 **COLOR:** Black / Blue

SKU: EVCG6H113 **COLOR:** Black / Rhodamine

SKU: EVCG6H114 **COLOR:** Black / Red

CYCLING GLOVES



ERGO

Comfortable fit
Anatomic shape
Breathable and flexible
Maximum protection and durability
Adjustable velcro closure

SKU: EVWG2F341 COLOR: Gray / Black / Yellow

SKU: EVWG2F342 COLOR: Red / Black / White

SKU: EVWG2F343 COLOR: Blue / Black / White

S - M - L - XL



STRADA

FULL FINGER DESIGN WITH COMFORTABLE AND
MAXIMUM PROTECTION DURING EVERY RIDE
ANATOMICAL THREE PANEL
PALM PADDING PROTECTS YOUR SENSITIVE
NERVE ENDINGS OF YOUR HANDS
REINFORCEMENTS AT HIGH ABRASION ZONES
FOR MAXIMUM PROTECTION AND DURABILITY
WRIST PULLER FOR EASY FIT
ADJUSTABLE AND SECURE CLOSURE

SKU: EVCG6H552 COLOR: Blue / Black

S - M - L - XL



GEL-V CYCLO & FITNESS GLOVE

- Pull off tabs for easy removal
- Comfortable fit
- Anatomically shaped
- Maximum grip and protection
- Adjustable velcro clos

SKU: EVC7H221 COLOR: Black / Neon Yellow

SKU: EVC7H229 COLOR: Black / Purple

S - M - L - XL

FEATURING
EVERCOOL™
TECHNOLOGY



H.I.T. HIGH INTENSITY TRAINING



WEIGHTLIFTING WRIST WRAPS

Wrist Wraps provide additional wrist support anytime you need it. Rubber closure for easy, custom tightening. Made from a cotton, elastic, and polyester blend that absorbs excess moisture and won't irritate the skin.

SKU: EVWR7R527 **COLOR:** Black

ENGINEERED FOR:
PROVIDE WRIST SUPPORT FOR BOTH MEN AND WOMEN AND CAN BE USED IN A WIDE VARIETY OF SPORTS AND FITNESS ACTIVITIES

ONE PAIR
LENGTH 20"



HIGH PERFORMANCE KNEE WRAPS

Made of heavy duty elastic, 78" inches long / 3" wide. Knee wraps provide therapy and compression for the knee. Cold pack therapy is recommended for optimum recovery of acute knee injuries.

Wear during intense training to help prevent injuries. One size fits all, sold as a pair.

NEW

SKU: EVKW9H752 **COLOR:** Black / Red

ENGINEERED FOR:
PROVIDE IMMENSE SUPPORT, STABILITY AND PROTECTION OF YOUR KNEES DESIGNED TO ADJUST TO YOUR MOVEMENTS WITH A HIGH-PERFORMANCE STRETCHABLE FABRIC. THE LIFTING WRAPS WEIGHTLIFTING SUPPORT BRACES ARE SURE TO OFFER YOU TOP-NOTCH STRETCHING WHICH FEELS EXTREMELY NATURAL.

ONE PAIR
LENGTH 78"



PROVIDE ADDITIONAL WRIST SUPPORT ANYTIME YOU NEED IT.



SPORTS CHALK **300g**

MAGNESIUM CARBONATE

Ideal for Gymnastics, Weight lifting and High Intensity Training.

Enhance the grip on all sort of bars and sports equipment.

Designed to reduce hand moisture for better traction

Helps prevent your hands from slipping on the barbell or rings

SKU: EVCK9R300



PALM PROTECTOR

Removes excess material from the fitness glove
Comfort-cooling solution for your hands
Radial finger loops provide fast on/off action
Optimum palm protection, positioning and grip

**ONE
SIZE
FITS ALL**

ENGINEERED FOR:
SUPERIOR HAND PROTECTION
DURING WEIGHTLIFTING

SKU: EVPP1000 **COLOR:** Black



PALM PROTECTOR

Superior hand protection during weightlifting.
Superior Grip.
Flexible and durable rubber material.

HOW TO USE

Slip fingers into the loops with the curved edge facing your thumb. Securely grip the bar and begin your training session.

**ONE
SIZE
FITS ALL**

ENGINEERED FOR:
SUPERIOR HAND PROTECTION
DURING WEIGHTLIFTING

SKU: EVPP7H094 **COLOR:** Black



GRIP GUARD

Ideal for exercises such as rope climbing, pull ups, olympic lifts and kettlebell workouts.

These gloves are extremely lightweight and durable.

Designed to maximize breathability while preventing moisture.

Gripper gloves are a good choice for anyone who wants to improve grip during training workouts.

FEATURING
EVERCOOL™
TECHNOLOGY

ENGINEERED FOR:
SPECIALLY DESIGNED
FOR HIGH INTENSITY
TRAINING WORKOUTS

SKU: EVWG5H444 **COLOR:** Black

S - M - L - XL



PRO GRIP WEIGHT LIFTING COTTON STRAPS

Grip flex technology adds extra cushioning and flexibility. Around the wrist during heavy lifting. Strap is made from heavy duty cotton and flex rubber for added strength and a “no-slip” grip. When using the strap, rubber side must always face bar. 20.5” extended length allows you to wrap the bar several times. 1.5” inches wide.

ONE PAIR
LENGTH 20.5"
1.5" IN WIDE

ENGINEERED FOR:
SUPERIOR HAND PROTECTION
DURING WEIGHTLIFTING

SKU: EVCS4H706 COLOR: Black



PRO WEIGHT LIFTING HOOKS

Increases the stability of the bar with a superior grip. Neoprene Wrist Pad Cushions Keeps Wrist In Proper Position To Help Prevent Hyper Extension. Increases strength and technique. Enjoy more gains in your training routines.

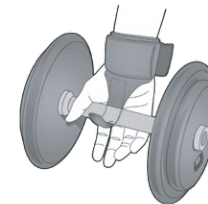

ONE SIZE
FITS ALL

ENGINEERED FOR:
SPECIALLY DESIGNED
FOR HIGH INTENSITY
TRAINING WORKOUTS

SKU: EVHK3W705 COLOR: Black

BAR PADS



SAFETY STRAPS
COMES WITH TWO VELCRO STRAPS TO KEEP THE SHOULDER FOAM PROTECTOR IN PLACE AND PREVENT INJURY.

SHOULDER FOAM PROTECTOR DIMENSIONS

17.5" X 3.5" X 1.3" THICK

Ergonomic pad designed to fit over any standard or olympic barbell .
Reduce the pressure on your back and shoulders when performing heavy squat sets.
Lightweight and compact, perfect for carrying in gym bags.
Easy to attach & remove in seconds.

Reduce the risk of injury .
Fits perfectly on all olympic size bars.
Anti-slip - it won't easily slip or roll around the bar for up most comfort.
Ergonomic design for even weight distribution across the shoulders .

SKU: EVSP9W032

COLOR: Gray





CONTOURED WEIGHT LIFTING BELT

Used during weightlifting activities.
Expanded back support & more comfort with less irritation.
Snug fit adds support and encourages proper form.
Created for comfort and flexibility, provides exceptional support for the back.
Encourages correct form throughout weight lifting routines.

SKU: EVSB4S39-SM COLOR: Black **S / M** FITS WAIST SIZES 24"/34".
SKU: EVSB4S39-ML COLOR: Black **M / L** FITS WAIST SIZES 34"/48".



UNIVERSAL WEIGHT LIFTING BELT

4"/6" WIDE WATERPROOF FOAM CORE BELT IS HAND WASHABLE, AIR DRY
One Adjustable Size.
Maximum lower back and abdominal support for heavier lifts!
Strong and durable.
This contoured belt helps you achieve killer results.
Safely and comfortably.

SKU: EVUB084 COLOR: Black **4"**
SKU: EVUB086 COLOR: Black **6"**



4" LEATHER WEIGHT BELT

Interior foam cushioning and suede lining for enhanced comfort.
Heavy duty dual pronged steel roller buckle secures tensioning.
Supports your lower back during those heavy brutal lifts.

ENGINEERED FOR:
SUPPORT
STABILITY
POWER

SKU: EVLB9H440 COLOR: Black

S M L XL



EVERLAST

**HYDRATION &
ACCESORIES**

HYDRATION



TOP

GRADIENT BOTTLE

STYLISH, DURABLE, CLEAR, SAFE
Plastic bottle with marker ml capacity
Hinged top lid, with silicone spout leak proof
Durable non-slip grip wrist strap
Quality Tests : BPA FREE

1000ml

SKU: **EVPB3Y100-BK** COLOR: **BLACK**
SKU: **EVPB3Y100-PK** COLOR: **PINK**

HYDRATION



TOP

SUMMIT BOTTLE

STYLISH, DURABLE, CLEAR, SAFE
Plastic bottle with marker ml capacity
Flip-top lid, with lock
Leak proof
Easy to take on the go
Quality Tests : BPA FREE

1300ml

SKU: **EVPB3Y130-BK** COLOR: **BLACK**

HYDRATION



LID



BACK

HIBRID SHAKER

STYLISH, DURABLE, SAFE
Supplement shaker bottle.
100% Stainless steel shaker bottle.
Leak proof.
Keep hot & cold.
Double wall vacuum insulation.
BPA FREE.

850ml
100% BPA-FREE

SKU: **EVSH3Y850-BK** COLOR: **BLACK**
SKU: **EVSH3Y850-NA** COLOR: **NAVY**

HYDRATION



LID



HANDLE

TUMBLER BOTTLE

STYLISH, DURABLE, SAFE
100% Stainless steel bottle.
Fits most cup holders.
Keep hot & cold.
Double wall vacuum insulation
Multifunctional cap.
Easy grip handle
BPA free.

900ml

SKU: **EVIB3Y900-BK** COLOR: **BLACK**
SKU: **EVIB3Y900-GD** COLOR: **GOLD**

HYDRATION



LID

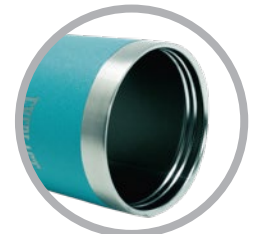

MOUTH



BOTTOM

EVERYDAY TUMBLER

STYLISH, DURABLE, SAFE
100% Stainless steel bottle.
Fits most cup holders.
Keep hot & cold.
Double wall vacuum insulation
Multifunctional cap.
BPA free.

900ml

SKU: **EVIB3Y890-NA** COLOR: **NAVY**
SKU: **EVIB3Y890-GN** COLOR: **GREEN**

HYDRATION



LID



MOUTH



BOTTOM

ESSENTIAL INSULATED MUG

STYLISH, DURABLE, CLEAR, SAFE
Made from 100% leak-proof stainless steel.
BPA free.
Keeps drinks hot or cold.
Double wall insulation.
Easy to use with one click button cap.

580ml
100% BPA-FREE

SKU: **EVCF3U423-BK** COLOR: **BLACK**
SKU: **EVCF3U423-GN** COLOR: **GREEN**
SKU: **EVCF3U423-PK** COLOR: **PINK**

HYDRATION



LID



MOUTH

VOYAGE INSULATED MUG

STYLISH, DURABLE, CLEAR, SAFE
Made from 100% leak-proof stainless steel.
BPA free.
Keeps drinks hot or cold.
Double wall insulation.

360ml
100% BPA-FREE

SKU: **EVCF3Y202-BK** COLOR: **BLACK**
SKU: **EVCF3Y202-RD** COLOR: **RED**
SKU: **EVCF3Y202-WT** COLOR: **WHITE**

HYDRATION



LID



STORAGE

PERFORM SHAKER

STYLISH, DURABLE, CLEAR, SAFE
Capacity marker in ml.
Storage compartment.
Easy to use with a one click button cap.
BPA FREE.

550ml
100% BPA-FREE

SKU: **EVSH3U550-BK** COLOR: **BLACK**
SKU: **EVSH3U550-GN** COLOR: **GREEN**

HYDRATION



LID



MIXER

500 SHAKER

STYLISH, DURABLE, CLEAR, SAFE
Plastic supplement mixer bottle.
MI ability marker.
Leak proof lid.
BPA FREE.

500ml

SKU: **EVSH3Y500-BK** COLOR: **BLACK**
SKU: **EVSH3Y500-PR** COLOR: **PURPLE**

HYDRATION



MOUTH



SCALE MARK



CAP



FILTER

TRITAN BOTTLE

STYLISH, DURABLE, CLEAR, SAFE
Store liquids safely in the -10°C to 96°C temperature range.
Convenient carrying lanyard handle.
Easy to use with single click push button lid.
Quality Tests : LFGB / SGS / BPA FREE

1000ml

SKU: **EVBP3U100-BK** COLOR: **BLACK**
SKU: **EVBP3U100-BL** COLOR: **BLUE**
SKU: **EVBP3U100-PR** COLOR: **PURPLE**

HYDRATION



LID



INSULATION PLUG



LID



MOUTH

X5 INSULATED BOTTLE

STYLISH, DURABLE, CLEAR, SAFE
Made from 100% leak-proof stainless steel.
BPA free.
Keeps drinks hot or cold.
Double wall insulation.
Easy to use with one click button cap.

680ml

SKU: **EVIB3U680-BK** COLOR: **BLACK**
SKU: **EVIB3U680-PK** COLOR: **PINK**

HYDRATION



MOUTH



CAP



SCALE MARK



STRAP

MOTION BOTTLE

STYLISH, DURABLE, CLEAR, SAFE

Store liquids safely in the -10°C to 96°C temperature range.

Convenient carrying lanyard handle.

Easy to use with single click push button lid.

Quality Tests : LFGB / SGS / BPA FREE

2300ml

SKU: EVIB3U230-NA COLOR: NAVY

HYDRATION



LARGE WATER BOTTLE MIXING & STORING

LARGE CAPACITY: 2.5 LITERS LARGE CAPACITY

Leak-proof

Does not contain BPA and phthalates.

Comfortable and portable.

Perfect for gym, bodybuilding, camping, travel, sports
and other outdoor activities.

2.5LT
100% BPA-FREE

SKU: EVJR9Y250 COLOR: GREY / RED

HYDRATION



500ml
100% BPA-FREE



600ml
100% BPA-FREE

TRITAN BOTTLE

STYLISH, DURABLE, CLEAR, SAFE

Store liquids safely in the -10°C to 96°C temperature range.

Convenient carrying lanyard handle.

Easy to use with single click push bottom lid.

Quality Tests : LFGB / SGS / BPA FREE

SKU: EVT9U511 COLOR: Black

SKU: EVT9U512 COLOR: Blue

500ml
100% BPA-FREE

SKU: EVT9Y003 COLOR: Navy

SKU: EVT9Y005 COLOR: Red

600ml
100% BPA-FREE

HYDRATION



TRITAN BOTTLE

STYLISH, DURABLE, CLEAR, SAFE

Handle: Integrated design, more convenient to carry.

Lid: Snap-on lid Magnetic adsorption

TPE Coating: Cap with TPE coating, streamlining design, skid proof.

Bottle Body: Unique concave-convex design, skid proof coating, more convenient to grasp.

730ml
100% BPA-FREE

SKU: EVPB2U731 COLOR: Black

SKU: EVPB2U733 COLOR: Blue



STAINLESS STEEL BOTTLE

ODORLESS, DURABLE, NON TOXIC, ANTI-BACTERIAL,
LEAK PROOF COVER.

Double-walled and vacuum-sealed.

Keeps contents hot or cold for hours,
does not sweat nor burn your hand.

Contoured design makes the bottle easy to hold.

1200ml

SKU: EVSS9Y200 COLOR: BLACK

HYDRATION



1500ml
100% BPA-FREE



1000ml
100% BPA-FREE



800ml
100% BPA-FREE



TRITAN BOTTLE

STYLISH, DURABLE, CLEAR, SAFE

Store liquids safely in the -10°C to 96°C temperature range.

Convenient carrying lanyard handle.

Easy to use with single click push bottom lid.

Quality Tests : LFGB / SGS / BPA FREE

SKU: EVTB2U151 1500ml COLOR: Black

SKU: EVTB2U103 1000ml COLOR: Dark Blue

SKU: EVTB2U106 1000ml COLOR: Bright Green

SKU: EVTB2U801 800ml COLOR: Black

SKU: EVTB2U807 800ml COLOR: Purplish Red



HYDRATION



LOCKING CAP

Single-hand Pressing open with safety lock seal



Fast flow



Leak proof



HYDRATION



TRITAN BOTTLE

STYLISH, DURABLE, CLEAR, SAFE

Store liquids safely in the -10°C to 96°C temperature range.

Convenient carrying lanyard handle.

Easy to use with single click push bottom lid.

Quality Tests : LFGB / SGS / BPA FREE

SKU: EVT9U101 **COLOR:** Grey **1000ml**
SKU: EVT9U102 **COLOR:** Blue **100% BPA-FREE**

SKU: EVT9U651 **COLOR:** Grey **650ml**
SKU: EVT9U652 **COLOR:** Pink **100% BPA-FREE**



HYDRATION



ANGLE BOTTLE

Maintains the temperature of drinks.
100% FREE BPA

750 ml

SKU: EVPB1P751 **COLOR:** Black
SKU: EVPB1P758 **COLOR:** White

HYDRATION



INSULATED WATER BOTTLE 750ml

INSULATED TECHNOLOGY

The double-wall construction of our insulated water bottles creates a thermal barrier of air to keep heat out and cold in. Foil layers reflect solar rays for additional thermal protection. This insulated bottle keeps liquid cold twice as long as Conventional bottles. 100 PERCENT BPA-FREE Constructed of low density polyethylene Also keeps warm beverages warm during cool weather rides

750 ml

SKU: EVIB1P750 - COLOR: BK

SKU: EVIB1P750 - COLOR: BL

SKU: EVIB1P750 - COLOR: MB

HYDRATION



PREMIUM INSULATED WATER BOTTLE 425ml

INSULATED TECHNOLOGY

The double-wall construction of our insulated water bottles creates a thermal barrier of air to keep heat out and cold in. Foil layers reflect solar rays for additional thermal protection.

This insulated bottle keeps liquid cold twice as long as Conventional bottles. 100% BPA-FREE Constructed of low density polyethylene

425 ml

SKU: EVIB1P420 COLOR: BK

SKU: EVIB1P420 COLOR: BL

SKU: EVIB1P420 COLOR: CH

HYDRATION



STAINLESS STEEL BOTTLE

ODORLESS, DURABLE, NON TOXIC, ANTI-BACTERIAL, LEAK PROOF COVER.

Double-walled and vacuum-sealed.

Keeps contents hot or cold for hours, does not sweat nor burn your hand.

Contoured design makes the bottle easy to hold.

750ml

SKU: EVSS9Y101 **COLOR:** Black

SKU: EVSS9Y105 **COLOR:** Wooden Blue

SKU: EVSS9Y108 **COLOR:** White

HYDRATION



INSULATED STAINLESS STEEL BOTTLE

ODORLESS, DURABLE, NON TOXIC, ANTI-BACTERIAL, LEAK PROOF COVER.

Double-walled and vacuum-sealed.

Keeps contents hot or cold for hours, does not sweat nor burn your hand.

Contoured design makes the bottle easy to hold.

Removable mesh filter - keeps ice from blocking the drinking spout.

800ml
ANTI-BACTERIAL

SKU: EVSS7Y301 **COLOR:** Black

SKU: EVSS7Y302 **COLOR:** Blue

SKU: EVSS7Y303 **COLOR:** Pink

HYDRATION



STAINLESS STEEL BOTTLE

LARGE CAPACITY: 2.5 LITERS LARGE CAPACITY

Leak-proof

It's a double-walled insulation.

It keeps your drink COLD for up to 24 hours, and HOT for up to 12 hours.

500ml
100% BPA-FREE

SKU: EVSS2U501 COLOR: CLOUDY BLACK

SKU: EVSS2U508 COLOR: PEAKS WHITE

HYDRATION



SHAKET BOTTLE MIXING AND STORING

STYLISH, DURABLE, CLEAR, SAFE

Handle: Portable and useful handle.

Lid: Snap-on lid Magnetic adsorption

Storage box: Screw type, easy to open it.

Bottle Body: nique style, spray coating, easy to carry

Seal It In - Leak-proof lid for clean and easy shaking and mixing

Taste your shake- Taste Guard Protection maintains tastes and resists odors

Store It- The storage container at the base holds up to two servings of powder or stores the mixer ball when not in use for added convenience

Round Up - Rounded bottom and weighted shaker ball are designed to work together to help reduce clumps and buildup common in other bottles

Carry On - Carry handle for easy transport

500ml
100% BPA-FREE

SKU: EVSH2U503 COLOR: Blue

HYDRATION



SHAKER BOTTLE MIXING & STORING

SUITABLE FOR SPORTS, TRAVEL, CAMPING AND HOME USE.
CAPACITY: 17 OUNCES (500 ML)

Our Shaker is specially designed to mix powdered drinks with ease and without clumps.

Includes storage compartments for nutritional supplements, vitamins, keys, snacks and much more.

Besides creating the perfect shake, it allows you to store and carry what you need in your daily active life.

500ml
100% BPA-FREE

SKU: EVSH9Y500 **COLOR:** Black / Red

HYDRATION



SHAKER BOTTLE MIXING & STORING

SUITABLE FOR SPORTS, TRAVEL, CAMPING AND HOME USE.
CAPACITY: 20 OUNCES (600 ML)

Our Shaker is specially designed to mix powdered drinks with ease and without clumps.

Includes storage compartments for nutritional supplements, vitamins, keys, snacks and much more.

Besides creating the perfect shake, it allows you to store and carry what you need in your daily active life.

SKU: EVSH9Y600 **COLOR:** Grey / Orange



600ml
100% BPA-FREE

HYDRATION



HYDRATION RUNNING BELT WITH 2 BOTTLES 10 OZ

Comfortable and bounce-free runners belt
Fits snugly enough to always stay comfortably in place.
Includes two bottles with push-pull caps for easy access to hydration during your run.
ZIP POCKETS – Front stash pouch for gels, keys etc. Fits 6.5 Inch Smartphones.



SKU: EVHY3W103 COLOR: Black / Neon Yellow



2 Bottles with Large Capacity



Gel-based Interior Lining



Night Reflector



Adjustable Belt



HYDRATION BELT

Running belt with large pocket can hold smartphones, keys, money, cards, and other essentials.
Fully adjustable strap to accommodate your waist.
Running belt with multifunctional pockets.
Zipper pocket to hold smartphones, keys, money, inhaler, and other essentials.



SKU: EVHY3W101 COLOR: Black



Breathability



Waterproof



Adjustable Belt

HYDRATION



CAMEL BAG 1.5L

Lightweight performance hydration backpack easy bladder loading system breathable shoulder straps, adjustable sternum strap, and cool mesh padded back cyclone hydration reservoir included.

43cm x 25cm

SKU: EV1CBB813 **COLOR:** Black / Orange

1,5 Litros

SKU: EV1CBB811 **COLOR:** Black / Grey



EVERLAST
E



FITNESS ACCESSORIES



MICROFIBER GYM TOWEL

IDEAL FOR GYM WORKOUT, SWIMMING AND TRAVEL.

Super absorbent

Antibacterial - keep your towel fresh and away from mildew & germ.

Ultra compact & light weight - easy to carry.

They can do their job well as travel towels or sports towels.

Also they are ideal for beach, travel, camping, swimming, backpacking, gym.

FEATURING
EVERDRI™
TECHNOLOGY

SKU: EVMT7L112 COLOR: Grey

SKU: EVMT7L113 COLOR: White

SKU: EVMT7L114 COLOR: Navy

ANTI-BACTERIAL
80 X 40cm



MICROFIBER CHAMOIS TOWELS

SUITABLE FOR USE AT: GYM OR FITNESS CLUB, SAUNA OR SPA,
HOME, HOTEL OR TRAVELLING AND EVERY OUTDOOR ACTIVITY

Microfiber chamois towels, ultra absorbent fabric Quick drying, soaps up water like sponge,
then wrings out water almost completely dry.

Re-usable mesh pouch ideal for everyday work out.

Super light weight and packable.

FEATURING
EVERFRESH™
TECHNOLOGY

SKU: EVCT7S171-BL COLOR: Blue

SKU: EVCT7S171-PK COLOR: Pink

SKU: EVCT7S171-GY COLOR: Grey

ANTI-BACTERIAL
80 X 40cm

SCRUNCHES



SCRUNCHES

SKU: EVBSC221 **COLOR:** Black

SKU: EVBSC226 **COLOR:** Green

SKU: EVBSC227 **COLOR:** Red



HEADBANDS



HEADBAND

SKU: EVBHB221 **COLOR:** Black

SKU: EVBHB222 **COLOR:** Charcoal

SKU: EVBHB227 **COLOR:** Red

SKU: EVBHB229 **COLOR:** Purple





4" WRISTBAND

SKU: EVWB4F401 **COLOR:** Black

SKU: EVWB4F403 **COLOR:** Navy

SKU: EVWB4F408 **COLOR:** White



2" WRISTBAND

SKU: EVWR6C201 **COLOR:** Black

SKU: EVWR6C202 **COLOR:** Navy

SKU: EVWR6C203 **COLOR:** Royal Blue

SKU: EVWR6C204 **COLOR:** White

SKU: EVWR6C205 **COLOR:** Pink

SKU: EVWR6C206 **COLOR:** Purple

HEADBANDS



1 cm BRAIDED HEADBAND

SKU: EVRHB783 COLOR: Blue



1 cm HEADBAND SET

SKU: EVHB1300 COLOR: Black, Lime, Blue, Pink



1 cm HAIRBAND SET

SKU: EVHR2300 COLOR: Black, Lime, Blue, Pink



HEADBANDS

Perfect For Any Sport
Lightweight Headband That Keeps Your Sweat And Hair Off Your Eyes
Breathable Fabric To Keep Your Head Feeling Cool And Dry
Absorbs Moisture Allowing You To Focus On What You're Doing
Embroidered Logo



1.5" HEADBAND

- SKU:** EVHB6C351 **COLOR:** Black
- SKU:** EVHB6C352 **COLOR:** Navy
- SKU:** EVHB6C353 **COLOR:** Royal Blue
- SKU:** EVHB6C354 **COLOR:** White
- SKU:** EVHB6C355 **COLOR:** Pink
- SKU:** EVHB6C356 **COLOR:** Purple

2" HEADBAND

- SKU:** EVHB6C501 **COLOR:** Black
- SKU:** EVHB6C502 **COLOR:** Navy
- SKU:** EVHB6C503 **COLOR:** White

2.5" HEADBAND

- SKU:** EVBHB001 **COLOR:**Black
- SKU:** EVBHB025 **COLOR:**Purple
- SKU:** EVBHB026 **COLOR:**Olive

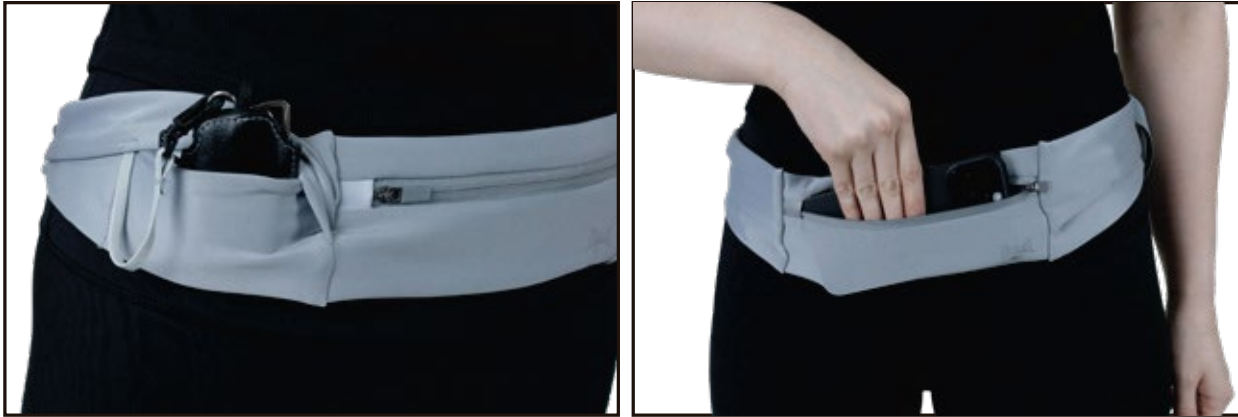

PREMIUM FITNESS WAISTBAG

Made of durable material for a long life.
Main zippered accessory pocket is great for keys, ID, cell phone.
Front pocket for small items.
light and fashionable
The durable belt adjusts to fit most waist sizes.

20cm x 13cm x 8cm

SKU: EVWB3WF04 **COLOR:** Gray

WAIST BAGS



FITNESS TRAINING WAIST PACK

6 cm wide 25cm long

Adjustable strap through the releasable buckle to ideal length
Great for sport, running or travelling
Pocket holds small phones, keys, money and other essentials
Comfortable soft elastic prevents chaffing while sturdy
Buckle and glides provide stability for the most active users

SKU: EVWB6I843 **COLOR:** Neon Green

6 x 25 CM



FIT BELT WAIST PACK

Comfortable and bounce-free runners belt
Fits snugly enough to always stay comfortably in place.
No matter how rigorous your workout gets, this exercise belt
Is guaranteed not to bounce or ride up your waist.

SKU: EVWB6I231 **COLOR:** Neon Yellow

SKU: EVWB6I232 **COLOR:** Neon Pink

SKU: EVWB6I235 **COLOR:** Black



WAIST BAGS



GYM WAIST BAG

Your running and workout essentials are close at hand and easy to access with this convenient unisex gym waist bag. A strong rear back clip fastens the stretch band securely around your hips to reduce bounce and distractions. Stash your phone, energy supplements and keys in the expandable pocket with easy open, zipper at the top.

In the back of the waist bag you can take out the cord of your earbuds from an rubber exit.

Adjust the belt to your perfect size.

This waist belt can be worn over or under your running tops, won't add bulk and is an essential for all gym workouts, also when going out, distance road and trail runners.

29.5cm x 6cm

SKU: EVWB0W801 **COLOR:** Black

SKU: EVWB0W802 **COLOR:** Camo

Back detail



COSMETIC BAG



**LOCKER ROOM
TRAVEL HAND BAG**

25 x 17 x 7 cm

SKU: EV5WSK212 **COLOR:** Neon yellow



BAG COSMETIC

Perfect organizer, it is lightweight and functional for everything while you travel.
Very useful for keeping all the little things organized.

23cm x 20cm x 7.5 cm

SKU: EVPB3N421 **COLOR:** Black

SKU: EVPB3N422 **COLOR:** Silver

PHONE HOLDER



PHONE HOLDER

SKU: EVAW0900-BK COLOR: Black
SKU: EVAW0900-PK COLOR: Pink

ONE SIZE
6.5"

FITNESS ACCESORIES



REFLECTIVE SAFETY VEST

Comfortable fit for maximum visibility and full range of motion
Reflective outer fabric and velvet lining
Velcro clouser

SKU: EVRV6S044
S/M - L/XL

FEATURING
EVERCOOL™
TECHNOLOGY



REFLECTIVE BAND

Increase your nighttime visibility with these highly reflective bands
They can be seen up to 1,000 feet.
That fit on both arms and legs. Easy to put on and unobtrusive,
One size fits all.

SKU: EVRFX200-PK
COLOR: Pink

3.0 cm wide 30.5cm long





COMPRESSION



+50 UV PROTECTION ARM SLEEVES

ADULTS, UNISEX / UNIVERSAL SIZE
Uv Protection 50+
Breathable Fabric With Moisture Control
Maximum Stretch For Snug Fit
Gripper Elastic Keeps The Sleeves In Place

ONE PAIR

SKU: EV1UVS201 COLOR: Black
SKU: EV1UVS235 COLOR: Sublimate

SKU: EV7UVS102 COLOR: White
SKU: EV7UVS103 COLOR: Blue

SM - LXL

S - M - L - XL



CALF COMPRESSION SLEEVES

CALF SUPPORT-SHIN SPLINT RELIEF DECREASED FATIGUE-INCREASED CIRCULATION
ADULTS, UNISEX / UNIVERSAL SIZE

Improved circulation and faster muscle recovery:
The compression in each pair of leg sleeves helps to improve venous return, increasing blood flow and circulation.
This leads to faster muscle recovery time, as muscles receive more of the oxygenated blood they need to recover.
It is also good for traveling, as it helps to reduce leg swelling.

ONE PAIR

SKU: EVCL6F001 COLOR: Black
SKU: EVCL6F002 COLOR: Neon Yellow

ONE SIZE



EASY TO CARRY ON

EXERCISE MATS



NON SLIP TEXTURIZED SURFACE

EASY TO CARRY



SUPER GRIP FITNESS MAT DOUBLE 10mm CUSHION

DESIGNED TO PROVIDE SUPERIOR AND COMFORTABLE FOUNDATION FOR ANY YOGA PRACTICE.

Non-slip surface provides stability.

Cushioned for extra comfort.

Suitable for beginners or experts.

Washable - just use soap and water

DIMENSIONS

EMBOSSED SWIRL

165cm x 58cm x 10mm

SKU: EVEM1S3-PK **COLOR:** Pink

SKU: EVEM1S3-BL **COLOR:** Blue

NBR EXERCISE MAT 15mm DOUBLE CUSHION

The yoga pilates exercise nbr mat is an excellent mat.

For people on the move, or for studios tight.

On storage space.

Non-slip surface provides stability.

Cushioned for extra comfort.

Suitable for beginners or experts.

Washable - just use soap and water.

173cm X 68cm X 15mm

SKU: EVEM111 **COLOR:** Blue

SKU: EVEM112 **COLOR:** Charcoal

SKU: EVEM113 **COLOR:** Black



EXERCISE MATS



FITNESS MAT YOGA

Designed to provide superior and comfortable foundation for any yoga practice.
Ultra-lightweight construction.
Durable, no-slip traction.
Cushioned for extra comfort.
Suitable for beginners or experts

-
- | | |
|---------------------|---------------------------|
| SKU: EYYM302 | COLOR: Blue Grey |
| SKU: EYYM303 | COLOR: Blue Legion |
| SKU: EYYM304 | COLOR: Lilac |



HIGH DENSITY NBR 10 mm DOUBLE CUSHION

72" long 24" wide ensures comfort.
10 mm thick high-density foam protects wrists, knees, elbows, head, neck and ankles effectively.
Textured surface stabilizes your body and keeps you from slipping. Sweat resistant feature makes it easy to clean.
Eco - Friendly NBR material is non-toxic and odorless, and it's durable for long lasting use.
Portable and lightweight. Carrying strap is included for easy transport and storage.
Perfect for all types of yoga, pilates and other floor exercises.
Cushioned for extra comfort.
Non-slip surface provides stability.

-
- | | |
|---------------------|----------------------|
| SKU: EVEM010 | COLOR: Black |
| SKU: EVEM014 | COLOR: Blue |
| SKU: EVEM016 | COLOR: Purple |

EXERCISE EQUIPMENT



EXERCISE MAT

Provides comfort and support for floor exercises and conditioning routines

100cm x 50cm x 4cm

SKU: EVEM4TS45 **COLOR:** Grey / Black



ELITE WORKOUT 6 mm

MAT WITH EYELETS

Durable 6mm thick foam mat

Great for any floor exercise.

Lightweight and easy to roll up.

2 eyelets desing allows easy storage.

Easy to clean with a damp cloth.

It can hold exercise equipment on its surface protecting floors from scratches.

Made of pthalates - free PVC

Cushioned for extra comfort.

Non-slip surface provides stability.

177 x 65 cm

SKU: EVGM7L200 **COLOR:** Black



The Everlast logo is displayed in white on a red square background. It features the word "EVERLAST" in a bold, serif font, with a stylized "E" underneath it.

TERAPHY & PROTECTOR



FITNESS ACCESSORIES



CIRCULAR MASSAGER

Dual textured rolling massage points for arms, forearms, elbows, legs, calves, neck, and other sore or aching areas 4-Point Massage roller target sore muscles from all four points for instant relief, Foam Roller helps relieve tendinitis including carpal tunnel and tennis elbow.

4
ROLLER
POINTS

SKU: EVMS3W903 COLOR: Black



MASSAGE ROLLER

Excellent for soothing muscle pains, balance exercises, and strength conditioning. Use your own body weight to help increase blood flow and circulation to the soft tissues Improve springiness, range of motion, minimize pain and soreness

FEATURES AND SPECIFICATIONS

Molded polyethylene foam technology and semi-firm surface that will not loose its shape after multiple uses

33
cm

SKU: EVRL3W330 COLOR: Grey

FITNESS ACCESSORIES



33cm MASSAGE ROLLER

Excellent for soothing muscle pains, balance exercises, and strength conditioning. Use your own body weight to help increase blood flow and circulation to the soft tissues. Improve springiness, range of motion, minimize pain and soreness.

FEATURES AND SPECIFICATIONS

Molded polyethylene foam technology and semi-firm surface that will not lose its shape after multiple uses.

33
cm

SKU: EVRL9W330 **COLOR:** Black / Red



FOAM ROLLER

Excellent for soothing muscle pains, balance exercises, and strength conditioning. Use your own body weight to help increase blood flow and circulation to the soft tissues. Improve springiness, range of motion, minimize pain and soreness.

FEATURES AND SPECIFICATIONS

Molded polyethylene foam technology. Smooth and semi-firm surface that will not lose its shape after multiple uses.

SKU: EVFR4I036 36" **COLOR:** Black

SKU: EVFR4I024 24" **COLOR:** Black

SKU: EVFR4I012 12" **COLOR:** Black

FITNESS ACCESSORIES



21" MASSAGE BAR

Soft tissue massage tool designed for faster muscle recovery.
Release muscle tension and soreness by increasing blood flow.
Portability for recovery on the go.
Recover faster.
Use before and after training.

SKU: EVMB81779 **COLOR:** Black / Yellow



**RELEASE MUSCLE TENSION
AND SORENESS BY INCREASING
BLOOD FLOW.**

HAND GRIPS



ADJUSTABLE HAND GRIP

Improve strength and dexterity of your hands, forearms, fingers and wrists with the patented Everlast Adjustable Hand Grip. Ergonomic silicone covered grip handle prevent slippage while high grade plastic shell provides unmatched durability. Easily toggle between two tension ranges with adjustable tension dial. Take one of your workouts on the go with the Everlast Adjustable Hand Grip.

20-30lbs
LOW TENSION

SKU: P00002727 COLOR: Red / Black

- Two tension ranges
- Silicone ergonomic grip handles
- Easy tension dial
- High grade plastic shell



ADJUSTABLE HAND GRIP

Improve strength and dexterity of your hands, forearms, fingers and wrists with the patented Everlast Adjustable Hand Grip. Ergonomic silicone covered grip handle prevent slippage while high grade plastic shell provides unmatched durability. Easily toggle between two tension ranges with adjustable tension dial. Take one of your workouts on the go with the Everlast Adjustable Hand Grip.

50-60lbs
HIGH TENSION

SKU: P00002728 COLOR: Black



HAND GRIP DELUXE

INCREASED GRIP ENDURANCE: Increasing strength in your hands, fingers, wrists and lower arms will increase endurance, allowing you to perform more repetitions and reach new heights at the gym. It will also enhance your ability to handle weights without the grip giving out.

NON-SLIP HAND GRIP: The handles on each side of our hand grip exerciser boast slip-resistant surfaces to ensure you can easily grip and hold with each squeeze.

1
PIECE

SKU: EVHG9W300 COLOR: Black

HAND GRIPS



HAND GRIP

INCREASED GRIP ENDURANCE: Increasing strength in your hands, fingers, wrists and lower arms.

NON-SLIP HAND GRIP: Ergonomic Design with soft Foam Handle fits all hand size for men and women, and providing a maximum comfort grip and anti-slipping.

**20
KG**

SKU: EVHG0W020 **COLOR:** Black



15kg



25kg

SILICONE HAND GRIP

Designed to fortify wrists, fingers and forearms.

Build a more powerful hand grip.

Ideal for strengthening after injury or surgery.

Comfortable, lightweight and compact.

Relieve stress.

SKU: EVSG2W250 **COLOR:** Black **25 kg**

SKU: EVSG2W150 **COLOR:** Blue **15 kg**



HAND GRIP BALL

Provides resistance exercise for hands,

Wrist, fingers and forearms helps

rehabilitation And improves mobility,

reduces stress.

Prevents stiffness.

Increases flexibility.

Relieves joint pain.

Reduces stress and eases muscle tension.

SKU: EVGR6R303 **COLOR:** Blue

FITNESS ACCESORIES



CORRECTIVE STRIPS OF BACK POSITION

The adjustable posture corrector helps improve your posture. Made of a light and breathable material. This stand has a discreet and slim design that works under clothing.

SKU: EVBP2W002 Color: Black

SM - ML





NEOPRENE WAISTBAND



NEOPRENE WAISTBAND

Everlast waistband designed to help you lose weight
Preserves body heat and promotes water loss during exercise
High -Quality neoprene construction
Comfortable and lightweight, easy velcro closure adjustable fit
It provides extra back support when walking or exercising

SKU: EVFA1S40
COLOR: Black, Grey, Blue

10"
10x40"
3mm

NEOPRENE WAISTBAND

Everlast waistband designed to help you lose weight
Preserves body heat and promotes water loss during exercise
High -Quality neoprene construction
Comfortable and lightweight, easy velcro closure adjustable fit
It provides extra back support when walking or exercising

SKU: EVFA1S48
COLOR: Black, Grey, Burgundy

8"
8x40"
3mm

BELTS



CORE SUPPORT SLIMMER BELT

FIT 30" TO 44"

- Rigid back provides superior back support
- Emphasizes proper alignment of core muscle
- Eases strain on lower back
- Promotes proper posture
- Slims appearance instantly
- Helps shed excess water

SKU: EVDW5S04

COLOR: Black

8.5"x44"

22 x 112 cms



CONTOURED SLIMMER BELT

FIT 30" TO 44"

- Reduce your waistband
- Preserve body heat
- Comfortable and lightweight
- Adjustable fit

SKU: EVDW5S13

COLOR: Grey

9"x42"

23 x 107 cms



NEOPRENE BACK SUPPORT

- System for maximum abdominal and back support
- Encourage correct posture
- Velcro closure for adjustable fit
- This product is designed and anatomically cut to fit the natural contour and shape of your body
- Our construction technology and innovative materials provide the best overall support while feeling comfortable with each movement

SKU: EVNBS330

COLOR: Black / Grey

S - M - L - XL



NEOPRENE & ELASTIC SUPPORTS



NEOPRENE WRIST SUPPORT

The Everlast neoprene wrist support is made from high quality neoprene rubber which provides constant uniform compression and support. It also retains warmth which increases blood circulation to injured area therefore promoting natural healing and comfort, in addition the warming effects on muscles and joints increase flexibility to help prevent sporting injuries.

SKU: EVNWS880

COLOR: Grey

**ONE
SIZE**



TENNIS ELBOW SUPPORT

Maximum support and stability, compression and heat retention. Comfortable fit. This product is designed and anatomically cut to fit the natural contour and shape of your body. Our construction technology and innovative materials provide the best overall support while feeling comfortable with each movement. Everlast products will minimize the possibility of future injury when being worn during strenuous activities.

SKU: EVTES770

COLOR: Grey

**ONE
SIZE**



BASIC NEOPRENE ANKLE SUPPORT

Maximum support and stability, compression and heat retention. Comfortable fit. This product is designed and anatomically cut to fit the natural contour and shape of your body. Our construction technology and innovative materials provide the best overall support while feeling comfortable with each movement. Everlast products will minimize the possibility of future injury when being worn during strenuous activities.

SKU: EVNAS220

COLOR: Grey

S - M - L - XL



NEOPRENE & ELASTIC SUPPORTS



UNIVERSAL NEOPRENE ANKLE SUPPORT

Maximun support and stability, compression and heat retention
Comfortable fit
This product is designed and anatomically cut to fit the natural contour and shape of your body
Our construction technology and innovative materials provide the best overall support while feeling comfortable with each movement
Everlast products will minimize the possibility of future injury when being worn during strenuous activities

SKU: EVNAS110
COLOR: Grey

**ONE
SIZE**



NEOPRENE PATELLA STRAP

FULLY ADJUSTABLE PATELLA KNEE STRAP
ONE SIZES FITS ALL

Maximun support and stability
Compression and heat retention
Comfortable fit

This product is designed and anatomically cut to fit the natural contour and shape of your body
Our construction technology and innovative materials provide the best overall support while feeling comfortable with each movement
Everlast products will minimize the possibility of future injury when being worn during strenuous activities

This fully adjustable patella tendon knee support helps to ease painful, sore and weak knee joints by providing added compression against the patella tendon

SKU: EVPTS990
COLOR: Neon Yellow, Neon, Orange

**ONE
SIZE**



DUAL STRAP KNEE BRACE

Overlapping two strap closure offers wide range of personalized secure fit and preferred compression support.
It also helps provide protection from further injury
Compression tubes provide targeted compression and support.
Breathable, mesh fabric allows for a comfortable fit

SKU: EVNKS200
COLOR: Black

S/M - L /XL

NEOPRENE & ELASTIC SUPPORTS



NEOPRENE BASIC KNEE SUPPORT

Maximum support and stability
Compression and heat retention
Comfortable fit

SKU: EVNKS440

COLOR: Grey

S - M - L - XL



NEOPRENE DELUXE KNEE SUPPORT

Hinged knee stabilizer
Maximum support and stability
Compression and heat retention
Comfortable fit

SKU: EVNKS660

COLOR: Grey

S - M - L - XL



NEOPRENE REINFORCED KNEE SUPPORT

Hinged knee stabilizer
Maximum support and stability
Compression and heat retention
Comfortable fit

SKU: EVNKS550

COLOR: Grey

S - M - L - XL



NEOPRENE & ELASTIC SUPPORTS



UNIVERSAL KNEE BRACE

Anatomical contoured design provides optimal fit and compression support throughout full range of motion.
Air flow neoprene provides moisture wicking compression for therapeutic warmth and healing.
Compression padding provides targeted compression and support, relieve pain from runner's or jumper's knee.
3 strap closure offers wide range of personalized secure fit and preferred compression support.

SKU: EVNKU770
COLOR: Black

**ONE
SIZE**
28 - 44 cm



ELASTIC WRIST SUPPORT

SUPPORT AND STABILITY
COMPRESSION AND HEAT RETENTION
COMFORTABLE FIT
This product is designed and anatomically cut to fit the natural contour and shape of your body
Our construction technology and innovative materials provide the best overall support while feeling comfortable with each movement
Everlast products will minimize the possibility of future injury when being worn during strenuous activities

SKU: EVEW160
COLOR: Black

**ONE
SIZE**



ELASTIC ELBOW SUPPORT

SUPPORT AND STABILITY
COMPRESSION AND HEAT RETENTION
COMFORTABLE FIT
This product is designed and anatomically cut to fit the natural contour and shape of your body
Our construction technology and innovative materials provide the best overall support while feeling comfortable with each movement
Everlast products will minimize the possibility of future injury when being worn during strenuous activities

SKU: EVEE641
COLOR: Natural

SKU: EVEE164
COLOR: Black

S - M - L - XL

ELASTIC SUPPORTS



ELASTIC KNEE SUPPORT

SUPPORT AND STABILITY
COMPRESSION AND HEAT RETENTION
COMFORTABLE FIT

This product is designed and anatomically cut to fit the natural contour and shape of your body
Our construction technology and innovative materials provide the best overall support while feeling comfortable with each movement
Everlast products will minimize the possibility of future injury when being worn during strenuous activities

SKU: EVEK161

COLOR: Black

SKU: EVEK162

COLOR: Natural

S - M - L - XL



ELASTIC ANKLE SUPPORT

SUPPORT AND STABILITY
COMPRESSION AND HEAT RETENTION
COMFORTABLE FIT

This product is designed and anatomically cut to fit the natural contour and shape of your body
Our construction technology and innovative materials provide the best overall support while feeling comfortable with each movement
Everlast products will minimize the possibility of future injury when being worn during strenuous activities

SKU: EVEA161

COLOR: Black

SKU: EVEA168

COLOR: Natural

S - M - L - XL



THERAPEUTIC BANDAGE

Multipurpose elastic compression bandage for first aiders. Helps stabilize and reduce pain, as well as the pain of a sprain. It can also help secure a splint after a fracture or sprain.

SKU: EVEB4W831
COLOR: Black
SKU: EVEB4W832
COLOR: Blue



ATHLETIC WRAP

Self adhesive design: these elastic bandages are far better than the non-adhesive one as they have self-adhering ability so that the tape doesn't loosen and fall off easily. Great therapeutic value: our tapes are sterile and they have great medicinal value, which is good for swelling, sprain and general soreness

SKU: EVAT6I101
COLOR: Black
SKU: EVAT6I102
COLOR: Blue

SKU: EVAT6I104
COLOR: Neon Green
SKU: EVAT6I105
COLOR: White

75 mm
x 2m



**FITNESS
ACCESSORIES**



**PARA MAYOR INFORMACIÓN COMUNÍQUESE
CON SU EJECUTIVO DE VENTAS**

DEPORTES JIMMY CR S.A
AN AUTHORIZED LICENSEE OF EVERLAST WORLDWIDE INC,
Ofibodegas Capri, Bodega #20, de Multiplaza Escazú, 1 km al norte,
contiguo al Colegio Blue Valley. Guachipelín.
San José, Costa Rica

T: (506) 2215 1578 / 2215 1745

C: ventascr@djimmy.net

WWW.EVERLASTLATAM.COM



@EVERLAST.CR
@EVERLASTLATINO



@EVERLASTLATAM